

На основу члана 63. Закона о јавним набавкама, Наручилац - Министарство привреде, Београд, Ул. Кнеза Милоша бр. 20 врши

ДОПУНУ I КОНКУРСНЕ ДОКУМЕНТАЦИЈЕ

ЗА ЈАВНУ НАБАВКУ БРОЈ 54/2016 – „Санација коловозне конструкције општинског пута Залоговац-Вратаре, 2. фаза, општина Варварин”

Конкурсна документација за јавну набавку број 54/2016 – „Санација коловозне конструкције општинског пута Залоговац-Вратаре, 2. фаза, општина Варварин”, допуњује се прилогом који чини саставни део Конкурсне документације.

PROFIL-1: OSA_0
 RAZMERA 1:1000/100

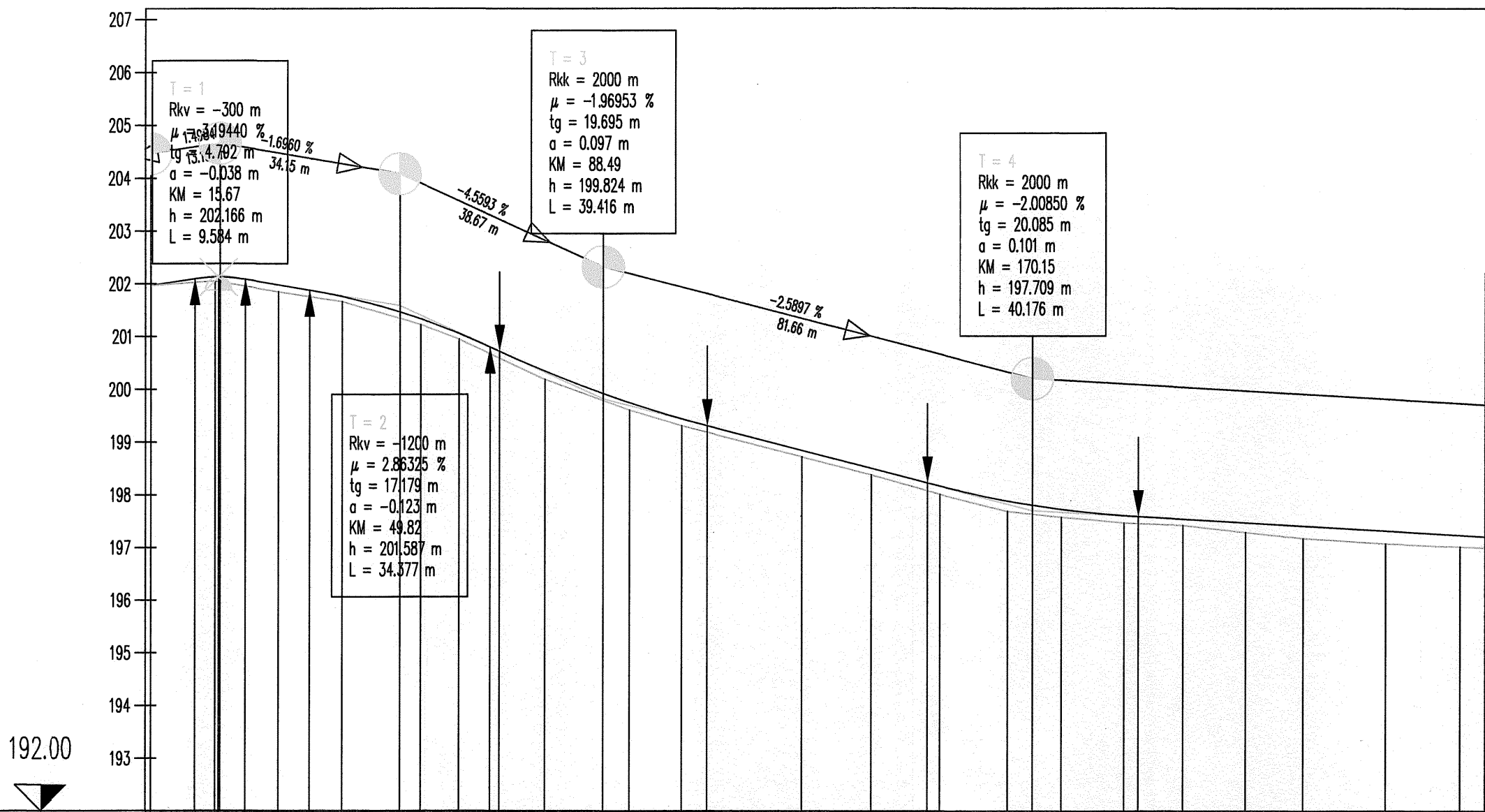

OZNAKE PROFILA	1	2	3	4	5	6	7	8	9	10	11	12	13	14	15	16	17	18	19	20	15	
STACION ŽE	2.54	14.71	26.73	38.82	53.75	61.09	71.42	83.48	93.36	106.21	119.35	132.41	145.43	158.63	171.51	184.71	197.92	210.58	223.52	236.22	249.28	
KOTE TEŽNA	201.969	202.052	201.848	201.661	201.228	200.949	200.192	199.609	199.314	198.725	198.380	198.014	197.693	197.582	197.471	197.426	197.293	197.178	197.076	197.020	197.020	
KOTE NIŠLETE	201.969	202.127	201.978	201.757	201.334	201.058	200.347	199.748	199.444	198.847	198.506	198.170	197.890	197.730	197.610	197.543	197.474	197.410	197.319	197.237	197.237	
PRAVCI KRIVINE	Pravac d=40.81		R=+90.00 lk=21.77		Pravac d=63.43		A=52.44 L=50.00		R=-55.00 lk=29.66		Pravac d=3.03		R=+45.00 lk=40.21		Pravac d=7.81							
POPREČNI NAGIBI	36.69		36.69		36.69		35.14		35.14		35.14		35.14		35.14		35.14		35.14		35.14	
	-0.443%		2.50%		2.50%		2.50%		-0.542%		4.00%		4.00%		4.00%		4.00%		4.00%		4.00%	
	-0.443%		-2.40%		-2.50%		-2.40%		-0.542%		-4.00%		-4.00%		-4.00%		-4.00%		-4.00%		-4.00%	

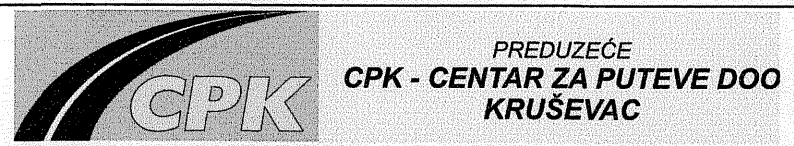

INVESTITOR	OPŠTINA VARVARIN
OBJEKAT	Opštinski put Zalogovac-Vratare
NAZIV PROJEKTA	GLAVNI PROJEKAT
ODGOVORNI PROJEKTANT	Borka Mladenović dipl.ing.građ.
CRTEŽ	Podužni profili od km 0+002.54 do km 0+251.28
RAZMERA	R - 1:1000/100
DATUM	08.2012.

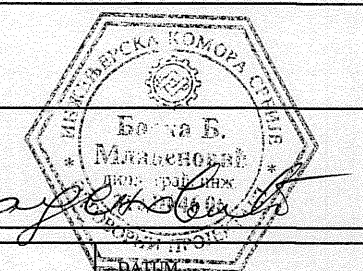



PROFIL-1: OSA_0
 RAZMERA 1:1000/100

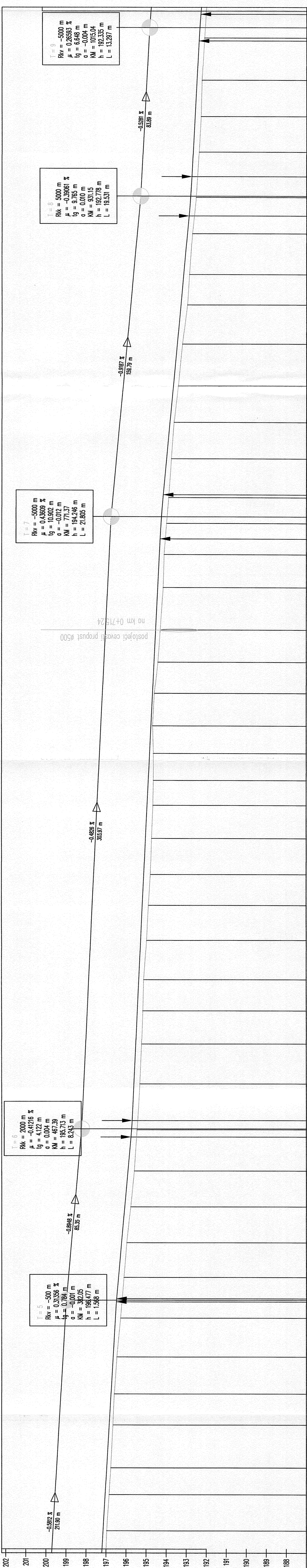

STACIONAŽE	KOTE TERENA	KOTE NIVELETE
188		
189		
190		
191		
192		
193		
194		
195		
196		
197		
198		
199		
200		
201		
202		
197.00	196.966	197.145
197.50	196.841	197.041
198.00	196.767	196.964
198.50	196.656	196.839
199.00	196.587	196.748
199.50	196.460	196.641
200.00	196.268	196.528
200.50	196.105	196.375
201.00	196.105	196.375
201.50	196.221	196.221
202.00	195.765	196.062
202.50	195.585	195.902
203.00	195.444	195.721
203.50	195.308	195.605
204.00	195.220	195.508
204.50	195.155	195.430
205.00	195.112	195.355
205.50	194.969	195.261
206.00	194.872	195.178
206.50	194.777	195.104
207.00	194.716	195.018
207.50	194.649	194.938
208.00	194.627	194.879
208.50	194.629	194.813
209.00	194.667	194.747
209.50	194.579	194.669
210.00	194.404	194.595
210.50	194.289	194.517
211.00	194.147	194.415
211.50	194.102	194.336
212.00	193.979	194.256
212.50	193.878	194.159
213.00	193.744	193.981
213.50	193.611	193.814
214.00	193.401	193.644
214.50	193.193	193.452
215.00	192.946	193.273
215.50	192.843	193.135
216.00	192.700	192.949
216.50	192.510	192.792
217.00	192.368	192.663
217.50	192.269	192.569
218.00	192.174	192.474
218.50	192.098	192.363
219.00		192.268
219.50		192.174
220.00		192.098
220.50		192.022
221.00		191.954
221.50		191.889
222.00		191.819
222.50		191.748
223.00		191.672
223.50		191.596
224.00		191.515
224.50		191.430
225.00		191.344
225.50		191.258
226.00		191.172
226.50		191.086
227.00		191.000
227.50		190.914
228.00		190.828
228.50		190.742
229.00		190.656
229.50		190.570
230.00		190.484
230.50		190.398
231.00		190.312
231.50		190.226
232.00		190.140
232.50		190.054
233.00		190.000
233.50		190.000
234.00		190.000
234.50		190.000
235.00		190.000
235.50		190.000
236.00		190.000
236.50		190.000
237.00		190.000
237.50		190.000
238.00		190.000
238.50		190.000
239.00		190.000
239.50		190.000
240.00		190.000
240.50		190.000
241.00		190.000
241.50		190.000
242.00		190.000
242.50		190.000
243.00		190.000
243.50		190.000
244.00		190.000
244.50		190.000
245.00		190.000
245.50		190.000
246.00		190.000
246.50		190.000
247.00		190.000
247.50		190.000
248.00		190.000
248.50		190.000
249.00		190.000
249.50		190.000
250.00		190.000
250.50		190.000
251.00		190.000
251.50		190.000
252.00		190.000
252.50		190.000
253.00		190.000
253.50		190.000
254.00		190.000
254.50		190.000
255.00		190.000
255.50		190.000
256.00		190.000
256.50		190.000
257.00		190.000
257.50		190.000
258.00		190.000
258.50		190.000
259.00		190.000
259.50		190.000
260.00		190.000
260.50		190.000
261.00		190.000
261.50		190.000
262.00		190.000
262.50		190.000
263.00		190.000
263.50		190.000
264.00		190.000
264.50		190.000
265.00		190.000
265.50		190.000
266.00		190.000
266.50		190.000
267.00		190.000
267.50		190.000
268.00		190.000
268.50		190.000
269.00		190.000
269.50		190.000
270.00		190.000
270.50		190.000
271.00		190.000
271.50		190.000
272.00		190.000
272.50		190.000
273.00		190.000
273.50		190.000
274.00		190.000
274.50		190.000
275.00		190.000
275.50		190.000
276.00		190.000
276.50		190.000
277.00		190.000
277.50		190.000
278.00		190.000
278.50		190.000
279.00		190.000
279.50		190.000
280.00		190.000
280.50		190.000
281.00		190.000
281.50		190.000
282.00		190.000
282.50		190.000
283.00		190.000
283.50		190.000
284.00		190.000
284.50		190.000
285.00		190.000
285.50		190.000
286.00		190.000
286.50		190.000
287.00		190.000
287.50		190.000
288.00		190.000
288.50		190.000
289.00		190.000
289.50		190.000
290.00		190.000
290.50		190.000
291.00		190.000
291.50		190.000
292.00		190.000
292.50		190.000
293.00		190.000
293.50		190.000
294.00		190.000
294.50		190.000
295.00		190.000
295.50		190.000
296.00		190.000
296.50		190.000
297.00		190.000
297.50		190.000
298.00		190.000
298.50		190.000
299.00		190.000
299.50		190.000
300.00		190.000

L. Nica
 D. Nica

CPK - CENTAR ZA PUTEVE DOO
 PREDUZEĆE
 KRUŠEVAC

INVESTITOR
 OPŠTINA VARVARIN

OPŠTINSKI PUT ZALOGOVAČ-VRTARE
 NAZIV PROJEKTA
 GLAVNI PROJEKAT

ODGOVORNI PROJEKTANT
 Borika Mladenović
 dipl.ing.grad.

CRTEŽ
 Poduzni profili od km 0+267.07 do km 1+026.01

RAZMERA
 R - 1:1000/100

LIST
 BR. 2

08.2012.

PROFIL-1: OSA_0
RAZMERA 1:1000/100

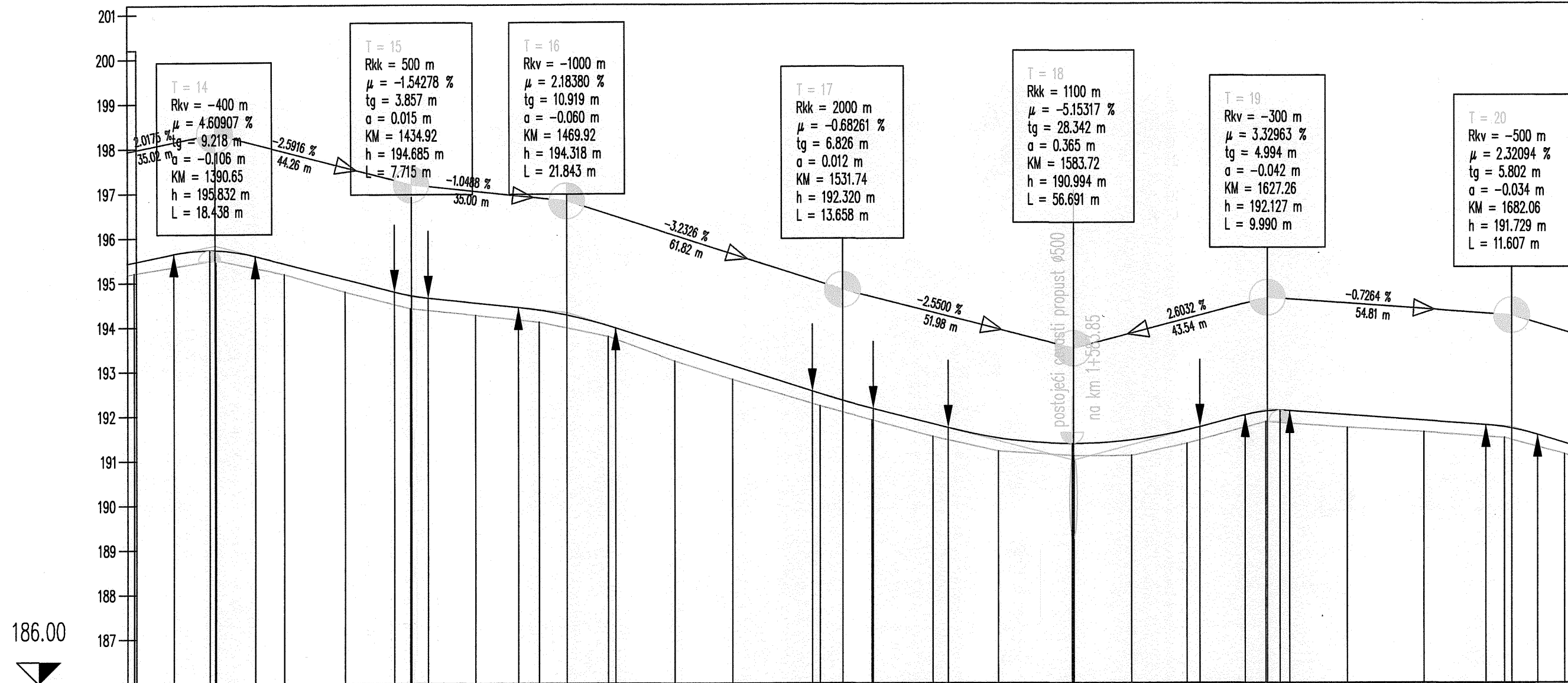

OZNAKE PROFILA	86 18.350 87 15.495 88 13.615 89 14.646 90 14.767 91 14.283 92 15.484 93 14.939 94 12.933 95 19.621 96 11.622 97 13.667 98 14.722 99 17.182 100 12.909 101 12.454 102 17.695 103 18.275 104 17.175 105 18.057 106 13.531 107
STACIONAŽE	72.52 90.87 1.4 6.37 19.98 34.63 49.40 63.68 79.16 94.10 1.5 7.04 26.66 38.28 51.95 66.67 83.85 96.76 9.21 26.91 45.18 62.36 80.41 83.95
KOTE TERENA	195.211 195.509 195.190 194.789 194.410 194.260 194.103 193.775 193.270 192.806 192.209 191.894 191.522 191.192 191.089 191.094 191.363 191.847 191.716 191.614 191.485 191.121
KOTE NIVELETE	195.466 195.725 195.425 195.072 194.705 194.533 194.373 194.018 193.536 193.118 192.485 192.153 191.804 191.487 191.359 191.440 191.661 192.082 191.997 191.872 191.724 191.367
PRAVCI I KRIVINE	Pravac d=32.56, R=+200.00, lk=30.16, Pravac d=29.02, R=+100.00, lk=10.11, Pravac d=9.87, R=+140.00, lk=33.75, A=50.00, L=25.00, A=50.00, L=25.00, A=27.39, R=-50.00, L=15.00, A=64.81, L=30.00
POPREČNI NAGIBI	Leva ivica: 5.0%, 2.50%, -0.250%, 4.00%, 4.00%, -0.250%, 2.50%, 2.50%, 2.50%, 2.50%, 2.50%, 2.50%, 2.50%, 2.50%, 2.50%, 2.50%, 4.00%, 4.00%, 2.50%. Desna ivica: 3.50%, -2.50%, -0.250%, -4.00%, -4.00%, -0.250%, 2.50%, -2.50%, -2.50%, -2.50%, -2.50%, -2.50%, -2.50%, -2.50%, -2.50%, -2.50%, -4.00%, -4.00%, -2.50%

CPK PREDUZEĆE CPK - CENTAR ZA PUTEVE DOO KRUŠEVAC

INVESTITOR: OPŠTINA VARVARIN
 Naziv Projekta: Opštinski put Zalogovac-Vratar
 Naziv Projekta: GLAVNI PROJEKAT
 ODGOVORNI PROJEKTANT: Borka Mladenović dipl.ing.građ.
 CRTEŽ: Podužni profili od km 1+372.52 do km 1+693.95
 RAZMERA: R - 1:1000/100
 DATUM: 05.2012.
 LIST BR.: 4

PROFIL-1: OSA_0
RAZMERA 1:1000/100

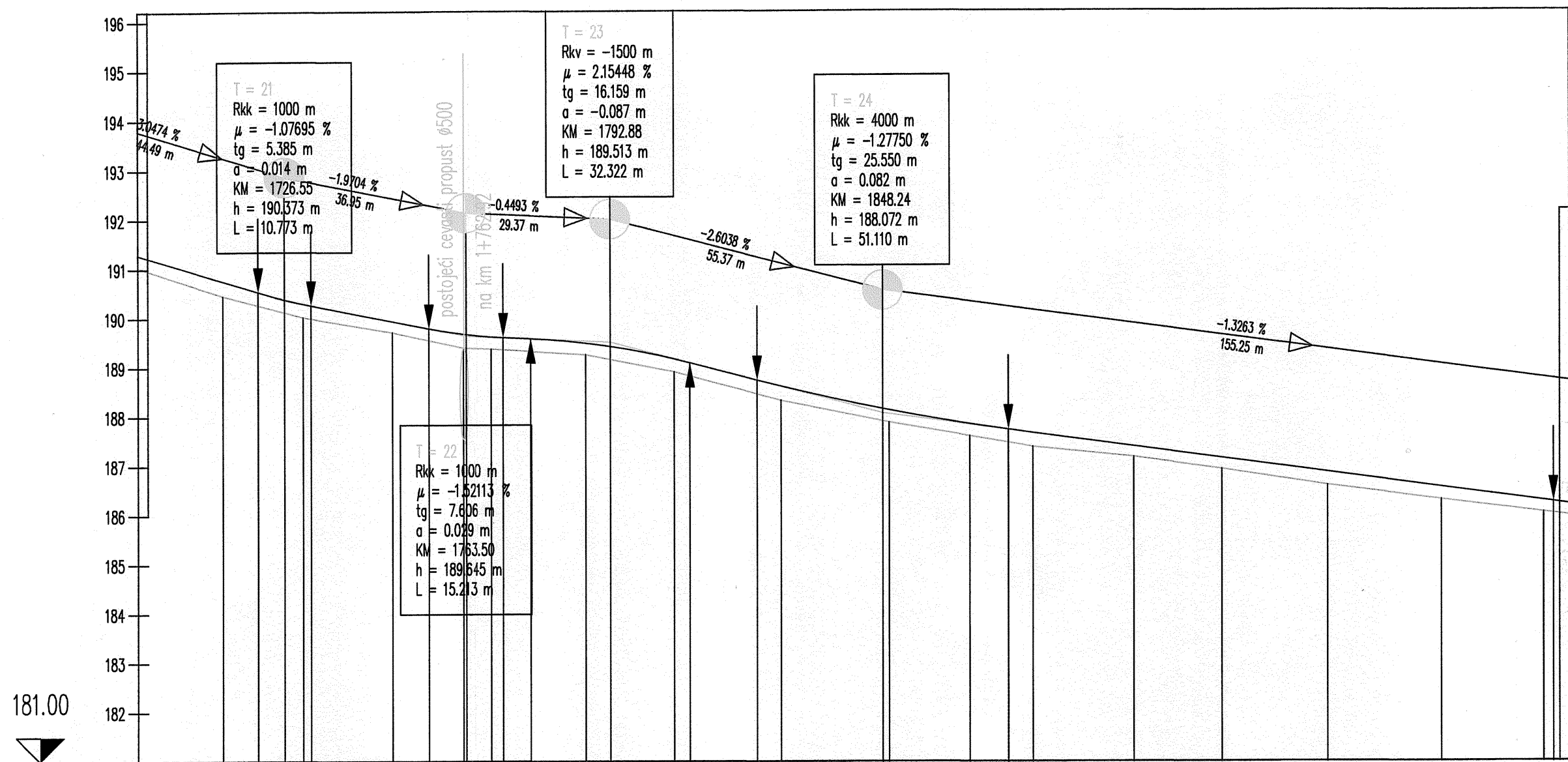

OZNAKE PROFILA	20.080	108	16.276	109	18.162	110	14.462	15.735	19.243	113	17.924	114	21.733	115	21.972	116	16.378	117	13.072	118	20.466	119	17.899	120	21.512	121	23.176	122	20.788	123
STACIONAŽE	1.7	14.03	30.30	48.46	62.92	68.66	87.90	1.8	5.83	27.56	49.53	65.91	78.98	99.45	17.35	38.86	62.03	82.82												
KOTE TERENA	190.458	190.027	189.718	189.400	189.380	189.262	189.909	188.326	187.880	187.599	187.383	187.178	186.930	186.602	186.311	186.050														
KOTE NIVELETE	190.755	190.301	189.942	189.681	189.625	189.494	189.173	188.613	188.128	187.845	187.664	187.393	187.155	186.870	186.563	186.287														
PRAVCI I KRIVINE																														
POPREČNI NAGIBI	2.50 %	2.50/2.60 %	2.50 %	2.50 %	2.50 %	2.50 %	2.50 %	2.50 %	2.50 %	2.50 %	2.50 %	2.50 %	2.50 %	2.50 %	2.50 %	2.50 %														
	2.50 %	2.50/2.60 %	2.50 %	2.50 %	2.50 %	2.50 %	2.50 %	2.50 %	2.50 %	2.50 %	2.50 %	2.50 %	2.50 %	2.50 %	2.50 %	2.50 %														

CPK PREDUZEĆE
CPK - CENTAR ZA PUTEVE DOO
KRUŠEVAC

INVESTITOR
OPŠTINA VARVARIN

Opštinski put Zalogovac-Vratare

NAZIV PROJEKTA
GLAVNI PROJEKAT

ODGOVORNI PROJEKTANT
Borka Mladenović
dipl.ing.građ.

CRTEŽ
Podužni profili od km 1+700.00 do km 1+982.82

RAZMERA
R - 1:1000/100

LIST
BR. **5**

08.2012.

PROFIL-1: OSA_0
 RAZMERA 1:1000/100

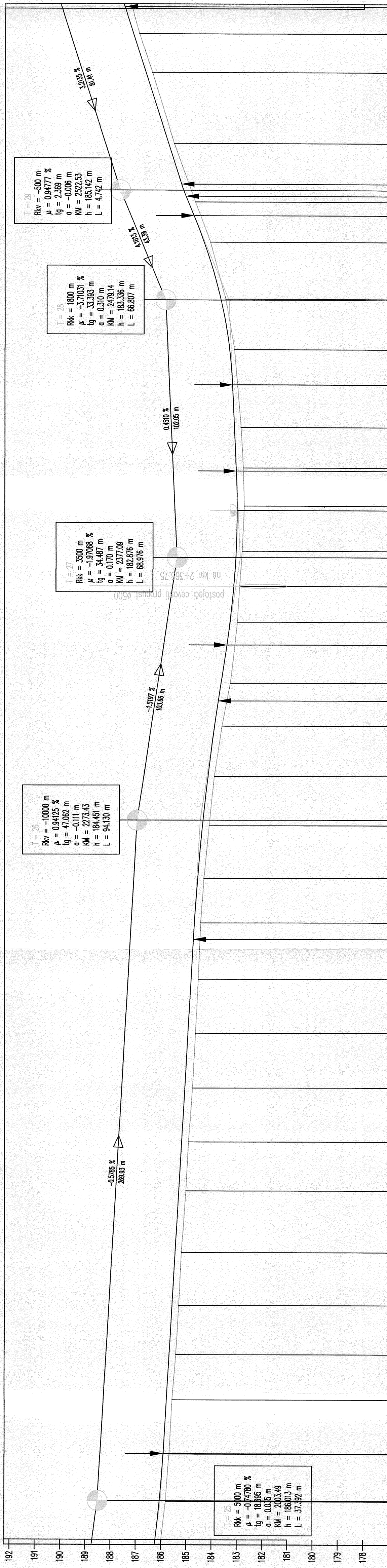

STACIONAŽE	KOTE TERENA	KOTE NIVELETE	STACIONAŽE	KOTE TERENA	KOTE NIVELETE
178			186	186.051	186.051
179			187	185.671	185.671
180			188	185.560	185.560
181			189	185.409	185.409
182			190	185.300	185.300
183			191	185.020	185.020
184			192	184.914	184.914
185			193	184.816	184.816
186			194	184.765	184.765
187			195	184.684	184.684
188			196	184.630	184.630
189			197	184.587	184.587
190			198	184.555	184.555
191			199	184.512	184.512
192			200	184.463	184.463
			201	184.319	184.319
			202	184.276	184.276
			203	184.233	184.233
			204	184.190	184.190
			205	184.147	184.147
			206	184.104	184.104
			207	184.061	184.061
			208	184.018	184.018
			209	183.975	183.975
			210	183.932	183.932
			211	183.889	183.889
			212	183.846	183.846
			213	183.803	183.803
			214	183.760	183.760
			215	183.717	183.717
			216	183.674	183.674
			217	183.631	183.631
			218	183.588	183.588
			219	183.545	183.545
			220	183.502	183.502
			221	183.459	183.459
			222	183.416	183.416
			223	183.373	183.373
			224	183.330	183.330
			225	183.287	183.287
			226	183.244	183.244
			227	183.201	183.201
			228	183.158	183.158
			229	183.115	183.115
			230	183.072	183.072
			231	183.029	183.029
			232	182.986	182.986
			233	182.943	182.943
			234	182.900	182.900
			235	182.857	182.857
			236	182.814	182.814
			237	182.771	182.771
			238	182.728	182.728
			239	182.685	182.685
			240	182.642	182.642
			241	182.599	182.599
			242	182.556	182.556
			243	182.513	182.513
			244	182.470	182.470
			245	182.427	182.427
			246	182.384	182.384
			247	182.341	182.341
			248	182.298	182.298
			249	182.255	182.255
			250	182.212	182.212
			251	182.169	182.169
			252	182.126	182.126
			253	182.083	182.083
			254	182.040	182.040
			255	181.997	181.997
			256	181.954	181.954
			257	181.911	181.911
			258	181.868	181.868
			259	181.825	181.825
			260	181.782	181.782
			261	181.739	181.739
			262	181.696	181.696
			263	181.653	181.653
			264	181.610	181.610
			265	181.567	181.567
			266	181.524	181.524
			267	181.481	181.481
			268	181.438	181.438
			269	181.395	181.395
			270	181.352	181.352
			271	181.309	181.309
			272	181.266	181.266
			273	181.223	181.223
			274	181.180	181.180
			275	181.137	181.137
			276	181.094	181.094
			277	181.051	181.051
			278	181.008	181.008
			279	180.965	180.965
			280	180.922	180.922
			281	180.879	180.879
			282	180.836	180.836
			283	180.793	180.793
			284	180.750	180.750
			285	180.707	180.707
			286	180.664	180.664
			287	180.621	180.621
			288	180.578	180.578
			289	180.535	180.535
			290	180.492	180.492
			291	180.449	180.449
			292	180.406	180.406
			293	180.363	180.363
			294	180.320	180.320
			295	180.277	180.277
			296	180.234	180.234
			297	180.191	180.191
			298	180.148	180.148
			299	180.105	180.105
			300	180.062	180.062
			301	180.019	180.019
			302	179.976	179.976
			303	179.933	179.933
			304	179.890	179.890
			305	179.847	179.847
			306	179.804	179.804
			307	179.761	179.761
			308	179.718	179.718
			309	179.675	179.675
			310	179.632	179.632
			311	179.589	179.589
			312	179.546	179.546
			313	179.503	179.503
			314	179.460	179.460
			315	179.417	179.417
			316	179.374	179.374
			317	179.331	179.331
			318	179.288	179.288
			319	179.245	179.245
			320	179.202	179.202
			321	179.159	179.159
			322	179.116	179.116
			323	179.073	179.073
			324	179.030	179.030
			325	178.987	178.987
			326	178.944	178.944
			327	178.901	178.901
			328	178.858	178.858
			329	178.815	178.815
			330	178.772	178.772
			331	178.729	178.729
			332	178.686	178.686
			333	178.643	178.643
			334	178.600	178.600
			335	178.557	178.557
			336	178.514	178.514
			337	178.471	178.471
			338	178.428	178.428
			339	178.385	178.385
			340	178.342	178.342
			341	178.299	178.299
			342	178.256	178.256
			343	178.213	178.213
			344	178.170	178.170
			345	178.127	178.127
			346	178.084	178.084
			347	178.041	178.041
			348	177.998	177.998
			349	177.955	177.955
			350	177.912	177.912
			351	177.869	177.869
			352	177.826	177.826
			353	177.783	177.783
			354	177.740	177.740
			355	177.697	177.697
			356	177.654	177.654
			357	177.611	177.611
			358	177.568	177.568
			359	177.525	177.525
			360	177.482	177.482
			361	177.439	177.439
			362	177.396	177.396
			363	177.353	177.353
			364	177.310	177.310
			365	177.267	177.267
			366	177.224	177.224
			367	177.181	177.181
			368	177.138	177.138
			369	177.095	177.095
			370	177.052	177.052
			371	177.009	177.009
			372	176.966	176.966
			373	176.923	176.923
			374	176.880	176.880
			375	176.837	176.837
			376	176.794	176.794
			377	176.751	176.751
			378	176.708	176.708
			379	176.665	176.665
			380	176.622	176.622
			381	176.579	176.579
			382	176.536	176.536
			383	176.493	176.493
			384	176.450	176.450
			385	176.407	176.407
			386	176.364	176.364
			387	176.321	176.321
			388	176.278	176.278
			389	176.235	176.235
			390	176.192	176.192
			391	176.149	176.149
			392	176.106	176.106
			393	176.063	176.063
			394	176.020	176.020
			395	175.977	175.977
			396	175.934	175.934
			397	175.891	175.891
			398	175.848	175.848
			399	175.805	175.805
			400	175.762	175.762
			401	175.719	175.719
			402	175.676	175.676
			403	175.633	175.633
			404	175.590	175.590
			405	175.547	175.547
			406	175.504	175.504
			407	175.461	175.461
			408	175.418	175.418
			409	175.375	175.375
			410	175.332	175.332
			411	175.289	175.289
			412	175.246	175.246
			413	175.203	175.203
			414	175.160	175.160
			415	175.117	175.117
			416	175.074	175.074
			417	175.031	175.031
			418	174.988	174.988
			419	174.945	174.945
			420	174.902	174.902
			421	174.859	174.859
			422	174.816	174.816
			423	174.773	174.773
			424	174.730	174.730
			425	174.687	174.687
			426	174.644	174.644
			427	174.601	174.601
			428	174.558	174.558
			429	174.515	174.515
			430	174.472	174.472
			431	174.429	174.429

PROFIL-1: OSA_0
RAZMERA 1:1000/100

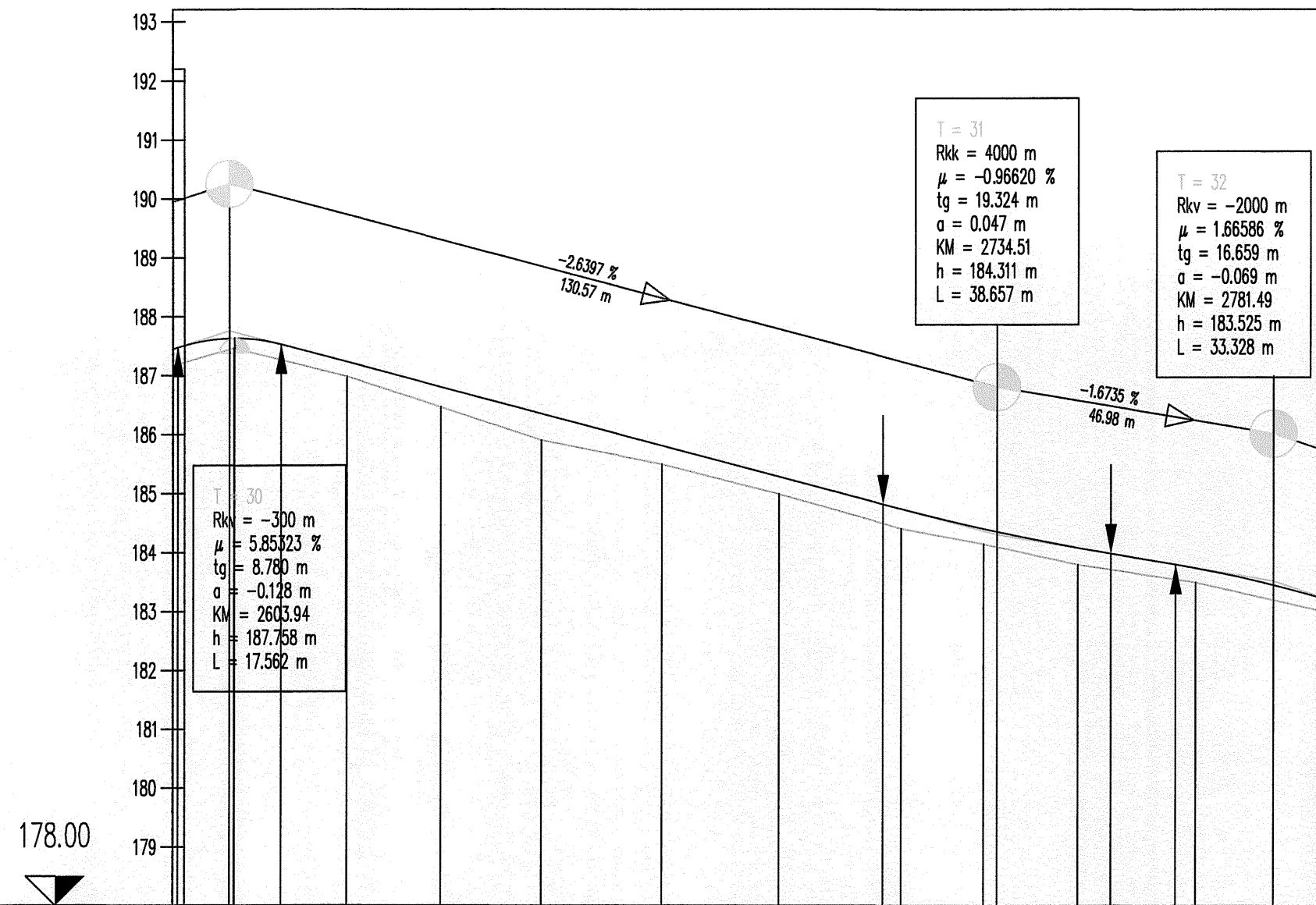

ÖZNAKE PROFILA	332 155 19.180 156 16.202 157 17.087 158 20.450 159 19.872 160 20.765 161 13.962 162 16.027 163 19.957 164 21.859 165
STACIONAŽE	2.670 4.70 23.88 40.09 57.17 77.62 97.49 18.26 32.22 48.25 68.21 90.07
ÖKOTE TERENA	187.465 186.981 186.467 185.906 185.500 184.994 184.411 184.152 183.799 183.501 183.007
ÖKOTE NIVELETE	187.631 187.232 186.804 186.353 185.813 185.289 184.742 184.408 184.085 183.745 183.223
ÖRAVCI I KRIVINE	
ÖOPREĐENI NAGIBI	

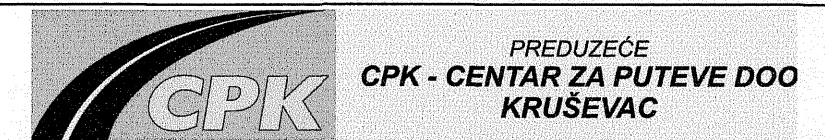

INVESTITOR
OPŠTINA VARVARIN
Opštinski put Zalogovac-Vratare

NAZIV PROJEKTA
GLAVNI PROJEKAT

ODGOVORNI PROJEKTANT
Borka Mladenović
dipl.ing.građ.

CRTEŽ
Podužni profili od km 2+600.00 do km2+790.07

RAZMERA
R - 1:1000/100

08.2012.

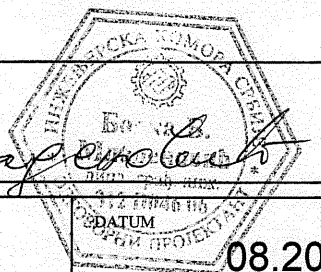

LIST BR. **7**

PROFIL-1: OSA_0
 RAZMERA 1:1000/100

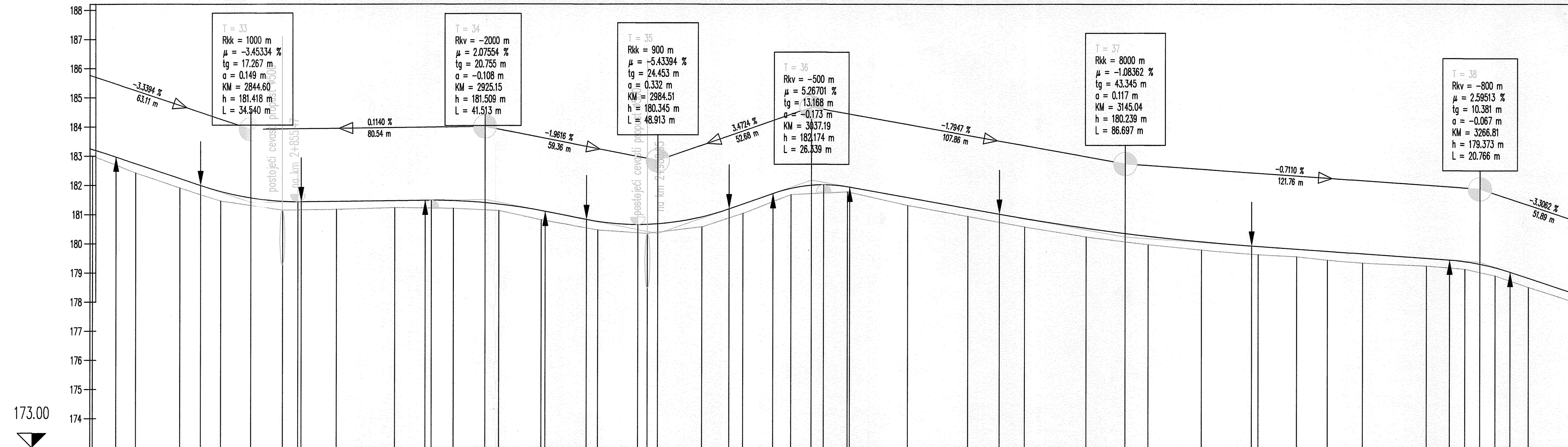

OZNAKE PROFILA	14.973	15.161	16.170	17.179	18.188	19.197	20.206	21.215	22.224	23.233	24.242	25.251	26.260	27.269	28.278	29.287	30.296	31.305	32.314	33.323	34.332	35.341	36.350	37.359	38.368	39.377	40.386	41.395	42.404	43.413	44.422	45.431	46.440	47.449	48.458	49.467	50.476	51.485	52.494	53.503	54.512	55.521	56.530	57.539	58.548	59.557	60.566	61.575	62.584	63.593	64.602	65.611	66.620	67.629	68.638	69.647	70.656	71.665	72.674	73.683	74.692	75.701	76.710	77.719	78.728	79.737	80.746	81.755	82.764	83.773	84.782	85.791	86.800	87.809	88.818	89.827	90.836	91.845	92.854	93.863	94.872	95.881	96.890	97.899	98.908	99.917	100.926	101.935	102.944	103.953	104.962	105.971	106.980	107.989	108.998	109.007	110.016	111.025	112.034	113.043	114.052	115.061	116.070	117.079	118.088	119.097	120.106	121.115	122.124	123.133	124.142	125.151	126.160	127.169	128.178	129.187	130.196	131.205	132.214	133.223	134.232	135.241	136.250	137.259	138.268	139.277	140.286	141.295	142.304	143.313	144.322	145.331	146.340	147.349	148.358	149.367	150.376	151.385	152.394	153.403	154.412	155.421	156.430	157.439	158.448	159.457	160.466	161.475	162.484	163.493	164.502	165.511	166.520	167.529	168.538	169.547	170.556	171.565	172.574	173.583	174.592	175.601	176.610	177.619	178.628	179.637	180.646	181.655	182.664	183.673	184.682	185.691	186.700	187.709	188.718	189.727	190.736	191.745	192.754	193.763	194.772	195.781	196.790	197.799	198.808	199.817	200.826	201.835	202.844	203.853	204.862	205.871	206.880	207.889	208.898	209.907	210.916	211.925	212.934	213.943	214.952	215.961	216.970	217.979	218.988	219.997	220.006	221.015	222.024	223.033	224.042	225.051	226.060	227.069	228.078	229.087	230.096	231.105	232.114	233.123	234.132	235.141	236.150	237.159	238.168	239.177	240.186	241.195	242.204	243.213	244.222	245.231	246.240	247.249	248.258	249.267	250.276	251.285	252.294	253.303	254.312	255.321	256.330	257.339	258.348	259.357	260.366	261.375	262.384	263.393	264.402	265.411	266.420	267.429	268.438	269.447	270.456	271.465	272.474	273.483	274.492	275.501	276.510	277.519	278.528	279.537	280.546	281.555	282.564	283.573	284.582	285.591	286.600	287.609	288.618	289.627	290.636	291.645	292.654	293.663	294.672	295.681	296.690	297.699	298.708	299.717	300.726	301.735	302.744	303.753	304.762	305.771	306.780	307.789	308.798	309.807	310.816	311.825	312.834	313.843	314.852	315.861	316.870	317.879	318.888	319.897	320.906	321.915	322.924	323.933	324.942	325.951	326.960	327.969	328.978	329.987	330.996	331.005	332.014	333.023	334.032	335.041	336.050	337.059	338.068	339.077	340.086	341.095	342.104	343.113	344.122	345.131	346.140	347.149	348.158	349.167	350.176	351.185	352.194	353.203	354.212	355.221	356.230	357.239	358.248	359.257	360.266	361.275	362.284	363.293	364.302	365.311	366.320	367.329	368.338	369.347	370.356	371.365	372.374	373.383	374.392	375.401	376.410	377.419	378.428	379.437	380.446	381.455	382.464	383.473	384.482	385.491	386.500	387.509	388.518	389.527	390.536	391.545	392.554	393.563	394.572	395.581	396.590	397.599	398.608	399.617	400.626	401.635	402.644	403.653	404.662	405.671	406.680	407.689	408.698	409.707	410.716	411.725	412.734	413.743	414.752	415.761	416.770	417.779	418.788	419.797	420.806	421.815	422.824	423.833	424.842	425.851	426.860	427.869	428.878	429.887	430.896	431.905	432.914	433.923	434.932	435.941	436.950	437.959	438.968	439.977	440.986	441.995	442.004	443.013	444.022	445.031	446.040	447.049	448.058	449.067	450.076	451.085	452.094	453.103	454.112	455.121	456.130	457.139	458.148	459.157	460.166	461.175	462.184	463.193	464.202	465.211	466.220	467.229	468.238	469.247	470.256	471.265	472.274	473.283	474.292	475.301	476.310	477.319	478.328	479.337	480.346	481.355	482.364	483.373	484.382	485.391	486.400	487.409	488.418	489.427	490.436	491.445	492.454	493.463	494.472	495.481	496.490	497.499	498.508	499.517	500.526	501.535	502.544	503.553	504.562	505.571	506.580	507.589	508.598	509.607	510.616	511.625	512.634	513.643	514.652	515.661	516.670	517.679	518.688	519.697	520.706	521.715	522.724	523.733	524.742	525.751	526.760	527.769	528.778	529.787	530.796	531.805	532.814	533.823	534.832	535.841	536.850	537.859	538.868	539.877	540.886	541.895	542.904	543.913	544.922	545.931	546.940	547.949	548.958	549.967	550.976	551.985	552.994	553.003	554.012	555.021	556.030	557.039	558.048	559.057	560.066	561.075	562.084	563.093	564.102	565.111	566.120	567.129	568.138	569.147	570.156	571.165	572.174	573.183	574.192	575.201	576.210	577.219	578.228	579.237	580.246	581.255	582.264	583.273	584.282	585.291	586.300	587.309	588.318	589.327	590.336	591.345	592.354	593.363	594.372	595.381	596.390	597.399	598.408	599.417	600.426	601.435	602.444	603.453	604.462	605.471	606.480	607.489	608.498	609.507	610.516	611.525	612.534	613.543	614.552	615.561	616.570	617.579	618.588	619.597	620.606	621.615	622.624	623.633	624.642	625.651	626.660	627.669	628.678	629.687	630.696	631.705	632.714	633.723	634.732	635.741	636.750	637.759	638.768	639.777	640.786	641.795	642.804	643.813	644.822	645.831	646.840	647.849	648.858	649.867	650.876	651.885	652.894	653.903	654.912	655.921	656.930	657.939	658.948	659.957	660.966	661.975	662.984	663.993	664.002	665.011	666.020	667.029	668.038	669.047	670.056	671.065	672.074	673.083	674.092	675.101	676.110	677.119	678.128	679.137	680.146	681.155	682.164	683.173	684.182	685.191	686.200	687.209	688.218	689.227	690.236	691.245	692.254	693.263	694.272	695.281	696.290	697.299	698.308	699.317	700.326	701.335	702.344	703.353	704.362	705.371	706.380	707.389	708.398	709.407	710.416	711.425	712.434	713.443	714.452	715.461	716.470	717.479	718.488	719.497	720.506	721.515	722.524	723.533	724.542	725.551	726.560	727.569	728.578	729.587	730.596	731.605	732.614	733.623	734.632	735.641	736.650	737.659	738.668	739.677	740.686	741.695	742.704	743.713	744.722	745.731	746.740	747.749	748.758	749.767	750.776	751.785	752.794	753.803	754.812	755.821	756.830	757.839	758.848	759.857	760.866	761.875	762.884	763.893	764.902	765.911	766.920	767.929	768.938	769.947	770.956	771.965	772.974	773.983	774.992	775.001	776.010	777.019	778.028	779.037	780.046	781.055	782.064	783.073	784.082	785.091	786.100	787.109	788.118	789.127	790.136	791.145	792.154	793.163	794.172	795.181	796.190	797.199	798.208	799.217	800.226	801.235	802.244	803.253	804.262	805.271	806.280	807.289	808.298	809.307	810.316	811.325	812.334	813.343	814.352	815.361	816.370	817.379	818.388	819.397	820.406	821.415	822.424	823.433	824.442	825.451	826.460	827.469	828.478	829.487	830.496	831.505	832.514	833.523	834.532	835.541	836.550	837.559	838.568	839.577	840.586	841.595	842.604	843.613	844.622	845.631	846.640	847.649	848.658	849.667	850.676	851.685	852.694	853.703	854.712	855.721	856.730	857.739	858.748	859.757	860.766	861.775	862.784	863.793	864.802	865.811	866.820	867.829	868.838	869.847	870.856	871.865	872.874	873.883	874.892	875.901	876.910	877.919	878.928	879.937	880.946	881.955	882.964	883.973	884.982	885.991	886.000	887.009	888.018	889.027	890.036	891.045	892.054	893.063	894.072	895.081	896.090	897.099	898.108	899.117	900.126	901.135	902.144	903.153	904.162	905.171	906.180	907.189	908.198	909.207	910.216	911.225	912.234	913.243	914.252	915.261	916.270	917.279	918.288	919.297	920.306	921.315	922.324	923.333	924.342	925.351	926.360	927.369	928.378	929.387	930.396	931.405	932.414	933.423	934.432	935.441	936.450	937.459	938.468	939.477	940.486	941.495	942.504	943.513	944.522	945.531	946.540	947.549	948.558	949.567	950.576	951.585	952.594	953.603	954.612	955.621	956.630	957.639	958.648	959.657	960.666	961.675	962.684	963.693	964.702	965.711	966.720	967.729	968.738	969.747	970.756	971.765	972.774	973.783	974.792	975.801	976.810	977.819	978.828	979.837	980.846	981.855	982.864	983.873	984.882	985.891	986.900	987.909	988.918	989.927	990.936	991.945	992.954	993.963	994.972	995.981	996.990	997.999	998.008	999.017	1000.026	1001.035	1002.044	1003.053	1004.062	1005.071	1006.080	1007.089	1008.098	1009.107	1010.116	1011.125	1012.134	1013.143	1014.152	1015.161	1016.170	1017.179	1018.188	1019.197	1020.206	1021.215	1022.224	1023.233	1024.242	1025.251	1026.260	1027.269</
----------------	--------	--------	--------	--------	--------	--------	--------	--------	--------	--------	--------	--------	--------	--------	--------	--------	--------	--------	--------	--------	--------	--------	--------	--------	--------	--------	--------	--------	--------	--------	--------	--------	--------	--------	--------	--------	--------	--------	--------	--------	--------	--------	--------	--------	--------	--------	--------	--------	--------	--------	--------	--------	--------	--------	--------	--------	--------	--------	--------	--------	--------	--------	--------	--------	--------	--------	--------	--------	--------	--------	--------	--------	--------	--------	--------	--------	--------	--------	--------	--------	--------	--------	--------	--------	--------	--------	---------	---------	---------	---------	---------	---------	---------	---------	---------	---------	---------	---------	---------	---------	---------	---------	---------	---------	---------	---------	---------	---------	---------	---------	---------	---------	---------	---------	---------	---------	---------	---------	---------	---------	---------	---------	---------	---------	---------	---------	---------	---------	---------	---------	---------	---------	---------	---------	---------	---------	---------	---------	---------	---------	---------	---------	---------	---------	---------	---------	---------	---------	---------	---------	---------	---------	---------	---------	---------	---------	---------	---------	---------	---------	---------	---------	---------	---------	---------	---------	---------	---------	---------	---------	---------	---------	---------	---------	---------	---------	---------	---------	---------	---------	---------	---------	---------	---------	---------	---------	---------	---------	---------	---------	---------	---------	---------	---------	---------	---------	---------	---------	---------	---------	---------	---------	---------	---------	---------	---------	---------	---------	---------	---------	---------	---------	---------	---------	---------	---------	---------	---------	---------	---------	---------	---------	---------	---------	---------	---------	---------	---------	---------	---------	---------	---------	---------	---------	---------	---------	---------	---------	---------	---------	---------	---------	---------	---------	---------	---------	---------	---------	---------	---------	---------	---------	---------	---------	---------	---------	---------	---------	---------	---------	---------	---------	---------	---------	---------	---------	---------	---------	---------	---------	---------	---------	---------	---------	---------	---------	---------	---------	---------	---------	---------	---------	---------	---------	---------	---------	---------	---------	---------	---------	---------	---------	---------	---------	---------	---------	---------	---------	---------	---------	---------	---------	---------	---------	---------	---------	---------	---------	---------	---------	---------	---------	---------	---------	---------	---------	---------	---------	---------	---------	---------	---------	---------	---------	---------	---------	---------	---------	---------	---------	---------	---------	---------	---------	---------	---------	---------	---------	---------	---------	---------	---------	---------	---------	---------	---------	---------	---------	---------	---------	---------	---------	---------	---------	---------	---------	---------	---------	---------	---------	---------	---------	---------	---------	---------	---------	---------	---------	---------	---------	---------	---------	---------	---------	---------	---------	---------	---------	---------	---------	---------	---------	---------	---------	---------	---------	---------	---------	---------	---------	---------	---------	---------	---------	---------	---------	---------	---------	---------	---------	---------	---------	---------	---------	---------	---------	---------	---------	---------	---------	---------	---------	---------	---------	---------	---------	---------	---------	---------	---------	---------	---------	---------	---------	---------	---------	---------	---------	---------	---------	---------	---------	---------	---------	---------	---------	---------	---------	---------	---------	---------	---------	---------	---------	---------	---------	---------	---------	---------	---------	---------	---------	---------	---------	---------	---------	---------	---------	---------	---------	---------	---------	---------	---------	---------	---------	---------	---------	---------	---------	---------	---------	---------	---------	---------	---------	---------	---------	---------	---------	---------	---------	---------	---------	---------	---------	---------	---------	---------	---------	---------	---------	---------	---------	---------	---------	---------	---------	---------	---------	---------	---------	---------	---------	---------	---------	---------	---------	---------	---------	---------	---------	---------	---------	---------	---------	---------	---------	---------	---------	---------	---------	---------	---------	---------	---------	---------	---------	---------	---------	---------	---------	---------	---------	---------	---------	---------	---------	---------	---------	---------	---------	---------	---------	---------	---------	---------	---------	---------	---------	---------	---------	---------	---------	---------	---------	---------	---------	---------	---------	---------	---------	---------	---------	---------	---------	---------	---------	---------	---------	---------	---------	---------	---------	---------	---------	---------	---------	---------	---------	---------	---------	---------	---------	---------	---------	---------	---------	---------	---------	---------	---------	---------	---------	---------	---------	---------	---------	---------	---------	---------	---------	---------	---------	---------	---------	---------	---------	---------	---------	---------	---------	---------	---------	---------	---------	---------	---------	---------	---------	---------	---------	---------	---------	---------	---------	---------	---------	---------	---------	---------	---------	---------	---------	---------	---------	---------	---------	---------	---------	---------	---------	---------	---------	---------	---------	---------	---------	---------	---------	---------	---------	---------	---------	---------	---------	---------	---------	---------	---------	---------	---------	---------	---------	---------	---------	---------	---------	---------	---------	---------	---------	---------	---------	---------	---------	---------	---------	---------	---------	---------	---------	---------	---------	---------	---------	---------	---------	---------	---------	---------	---------	---------	---------	---------	---------	---------	---------	---------	---------	---------	---------	---------	---------	---------	---------	---------	---------	---------	---------	---------	---------	---------	---------	---------	---------	---------	---------	---------	---------	---------	---------	---------	---------	---------	---------	---------	---------	---------	---------	---------	---------	---------	---------	---------	---------	---------	---------	---------	---------	---------	---------	---------	---------	---------	---------	---------	---------	---------	---------	---------	---------	---------	---------	---------	---------	---------	---------	---------	---------	---------	---------	---------	---------	---------	---------	---------	---------	---------	---------	---------	---------	---------	---------	---------	---------	---------	---------	---------	---------	---------	---------	---------	---------	---------	---------	---------	---------	---------	---------	---------	---------	---------	---------	---------	---------	---------	---------	---------	---------	---------	---------	---------	---------	---------	---------	---------	---------	---------	---------	---------	---------	---------	---------	---------	---------	---------	---------	---------	---------	---------	---------	---------	---------	---------	---------	---------	---------	---------	---------	---------	---------	---------	---------	---------	---------	---------	---------	---------	---------	---------	---------	---------	---------	---------	---------	---------	---------	---------	---------	---------	---------	---------	---------	---------	---------	---------	---------	---------	---------	---------	---------	---------	---------	---------	---------	---------	---------	---------	---------	---------	---------	---------	---------	---------	---------	---------	---------	---------	---------	---------	---------	---------	---------	---------	---------	---------	---------	---------	---------	---------	---------	---------	---------	---------	---------	---------	---------	---------	---------	---------	---------	---------	---------	---------	---------	---------	---------	---------	---------	---------	---------	---------	---------	---------	---------	---------	---------	---------	---------	---------	---------	---------	---------	---------	---------	---------	---------	---------	---------	---------	---------	---------	---------	---------	---------	---------	---------	---------	---------	---------	---------	---------	---------	---------	---------	---------	---------	---------	---------	---------	---------	---------	---------	---------	---------	---------	---------	---------	---------	---------	---------	---------	---------	---------	---------	---------	---------	---------	---------	---------	---------	---------	---------	---------	---------	---------	---------	---------	---------	---------	---------	---------	---------	---------	---------	----------	----------	----------	----------	----------	----------	----------	----------	----------	----------	----------	----------	----------	----------	----------	----------	----------	----------	----------	----------	----------	----------	----------	----------	----------	----------	----------	------------

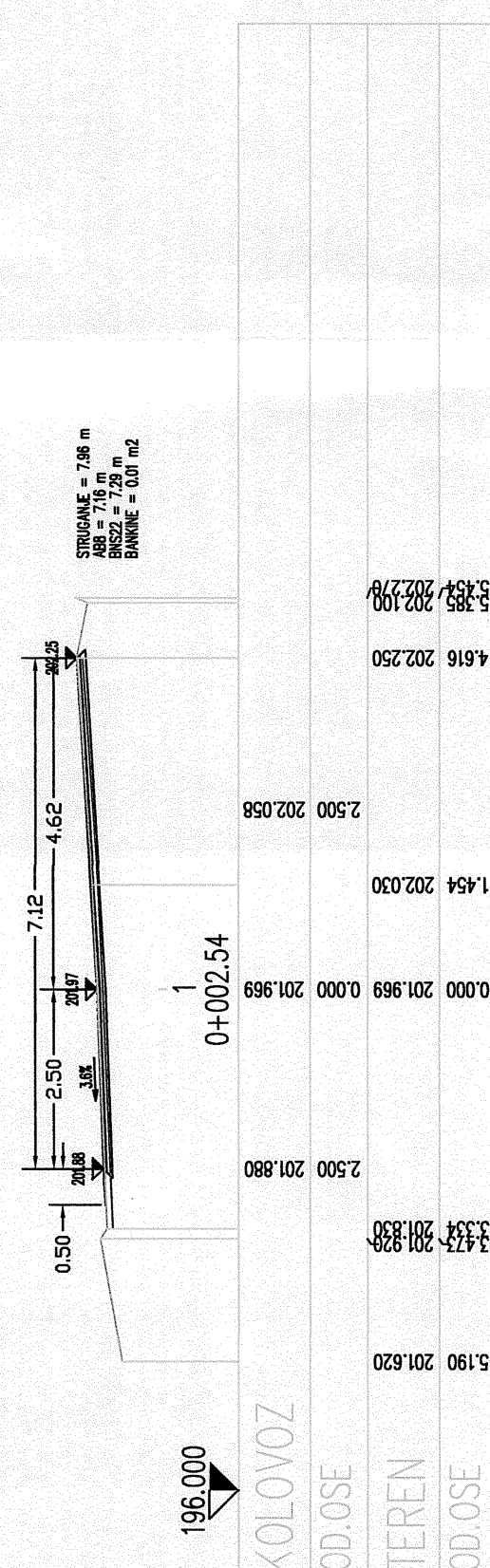

5.190	201.620	3.434	201.830	2.500	201.880	0.000	201.969	0.000	201.989	1.454	202.030	2.500	202.058	4.616	202.250	5.383	202.776
KOLOVOZ																	
OD.05E																	
TEREN																	
OD.05E																	

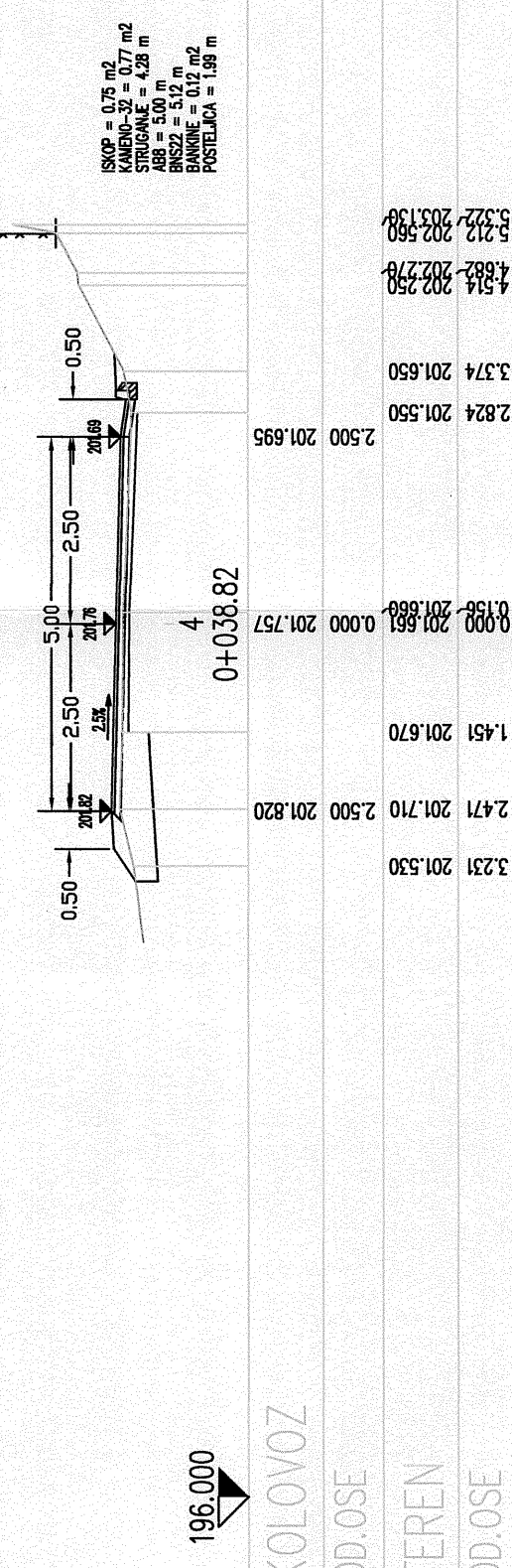

3.231	201.530	2.471	201.710	2.500	201.820	0.000	201.868	0.000	201.877	1.451	201.670	2.824	201.650	3.374	201.650	4.514	202.250	5.212	203.338
KOLOVOZ																			
OD.05E																			
TEREN																			
OD.05E																			

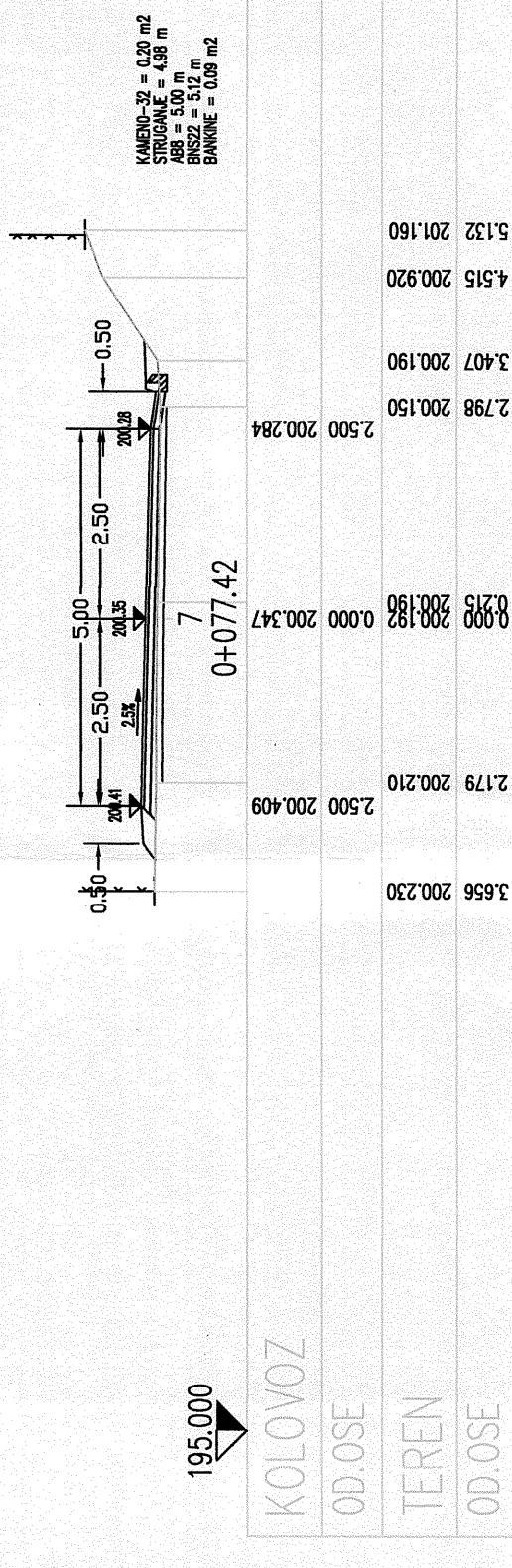

3.656	200.230	2.179	200.210	2.500	200.409	0.000	200.347	0.000	200.347	2.798	200.150	3.407	200.190	4.515	200.920	5.132	201.160
KOLOVOZ																	
OD.05E																	
TEREN																	
OD.05E																	

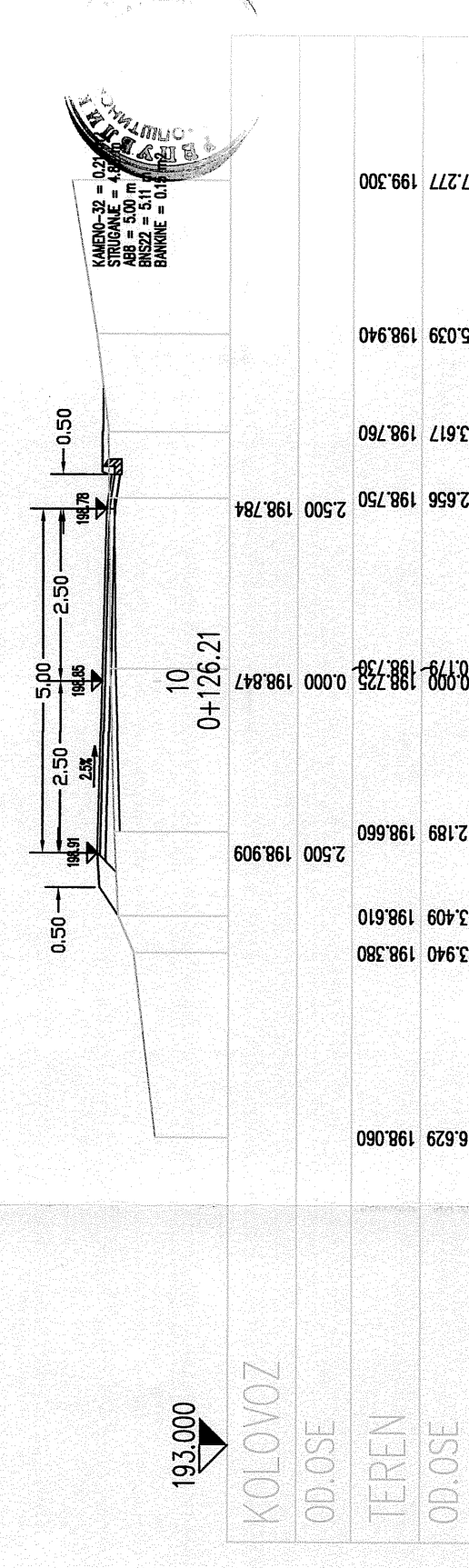

6.629	198.050	3.940	198.610	2.500	198.909	0.000	198.847	0.000	198.847	2.656	198.750	3.617	198.760	5.039	198.940	5.039	199.300	7.277	199.300
KOLOVOZ																			
OD.05E																			
TEREN																			
OD.05E																			

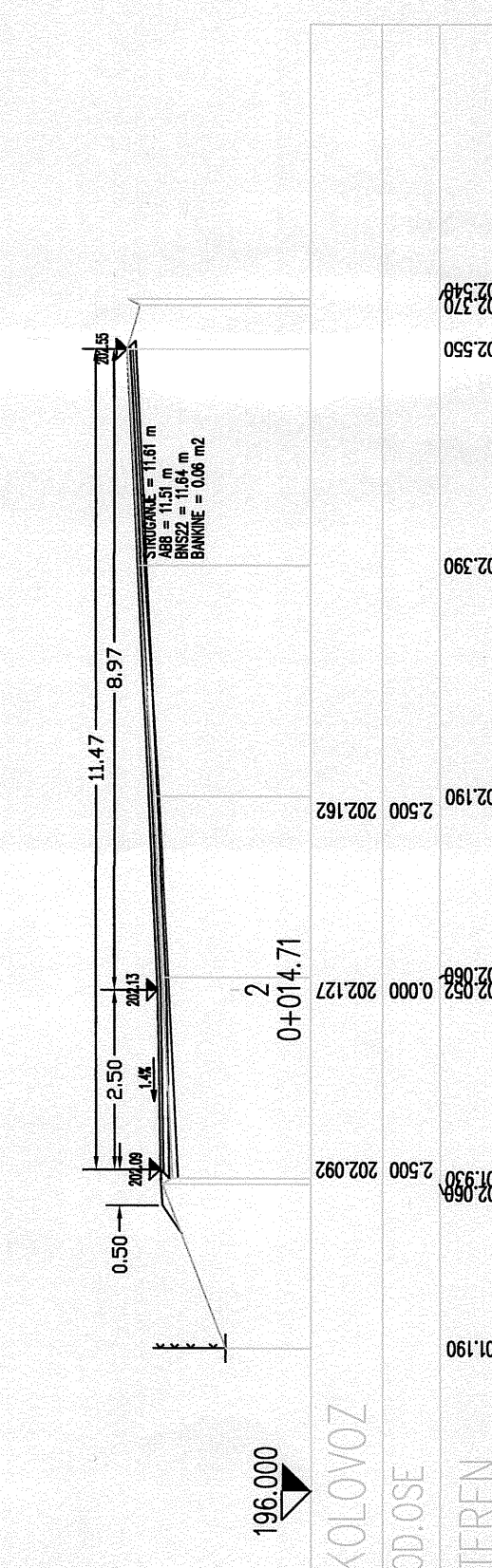

4.993	201.190	2.624	201.930	2.500	202.092	0.000	202.127	0.000	202.127	2.694	202.162	2.694	202.190	2.694	202.550	4.983	202.349	8.965	202.550
KOLOVOZ																			
OD.05E																			
TEREN																			
OD.05E																			

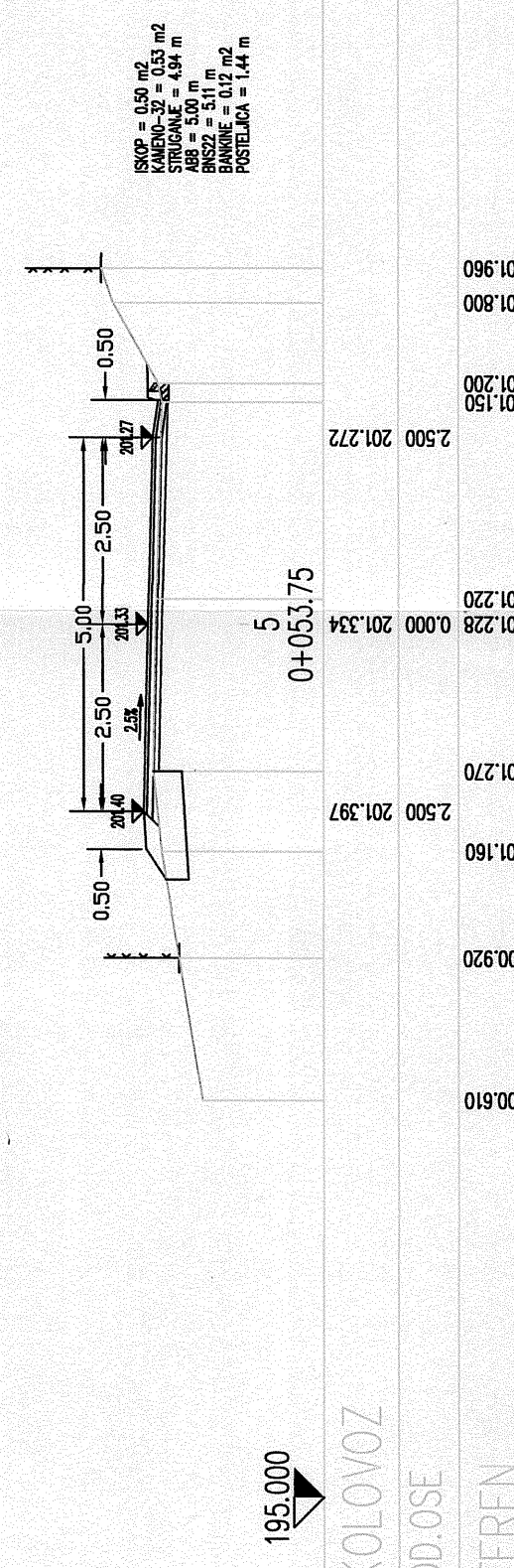

6.341	200.610	3.031	201.160	2.500	201.397	0.000	201.334	0.000	201.334	1.966	201.270	2.989	201.150	3.222	201.200	4.293	201.800	4.752	201.960
KOLOVOZ																			
OD.05E																			
TEREN																			
OD.05E																			

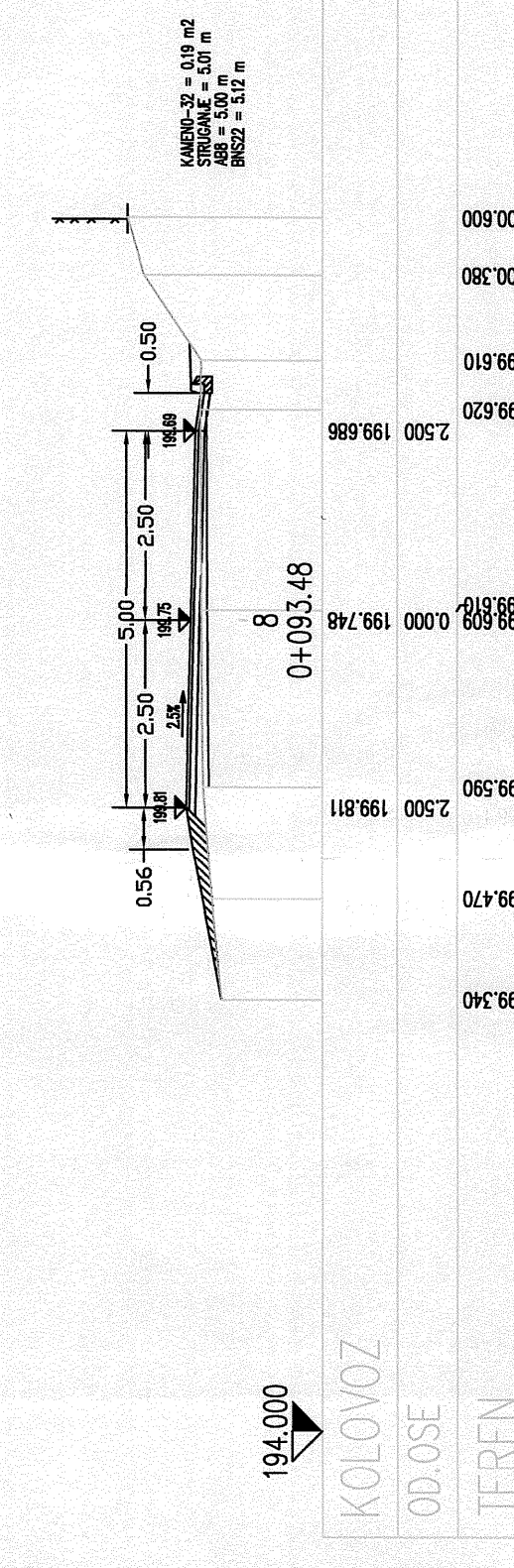

5.104	199.340	3.749	199.470	2.500	199.811	0.000	199.748	0.000	199.748	2.783	199.620	3.436	199.610	4.572	200.380	5.332	200.600
KOLOVOZ																	
OD.05E																	
TEREN																	
OD.05E																	

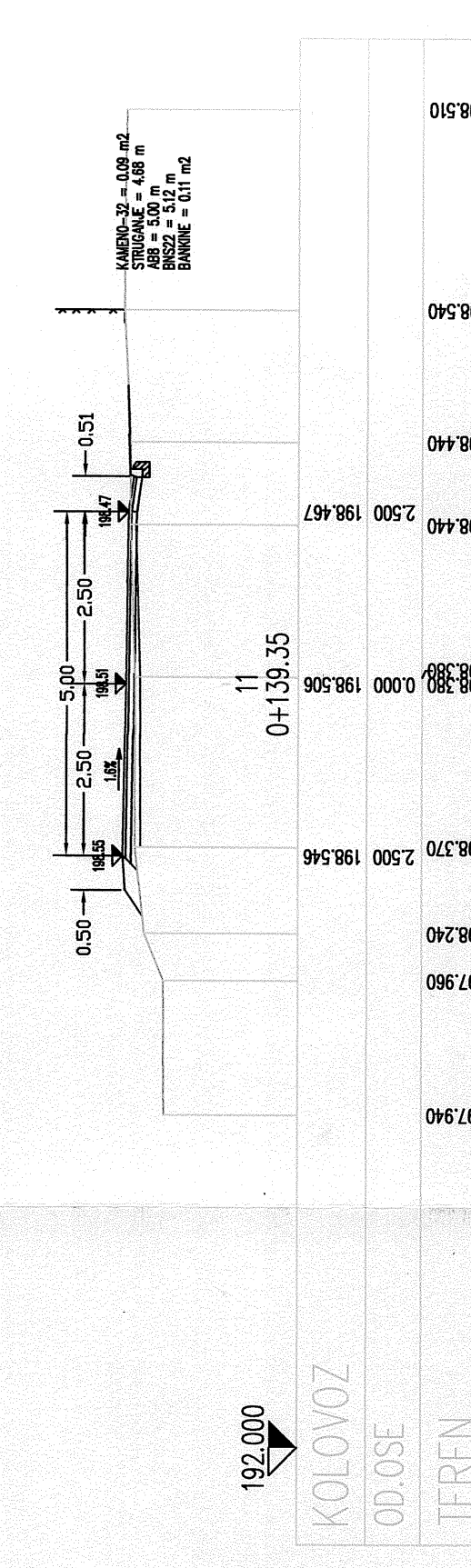

6.266	197.940	4.308	197.960	3.622	198.240	2.500	198.546	0.000	198.506	2.313	198.440	3.510	198.440	5.428	198.540	8.352	198.510
KOLOVOZ																	
OD.05E																	
TEREN																	
OD.05E																	

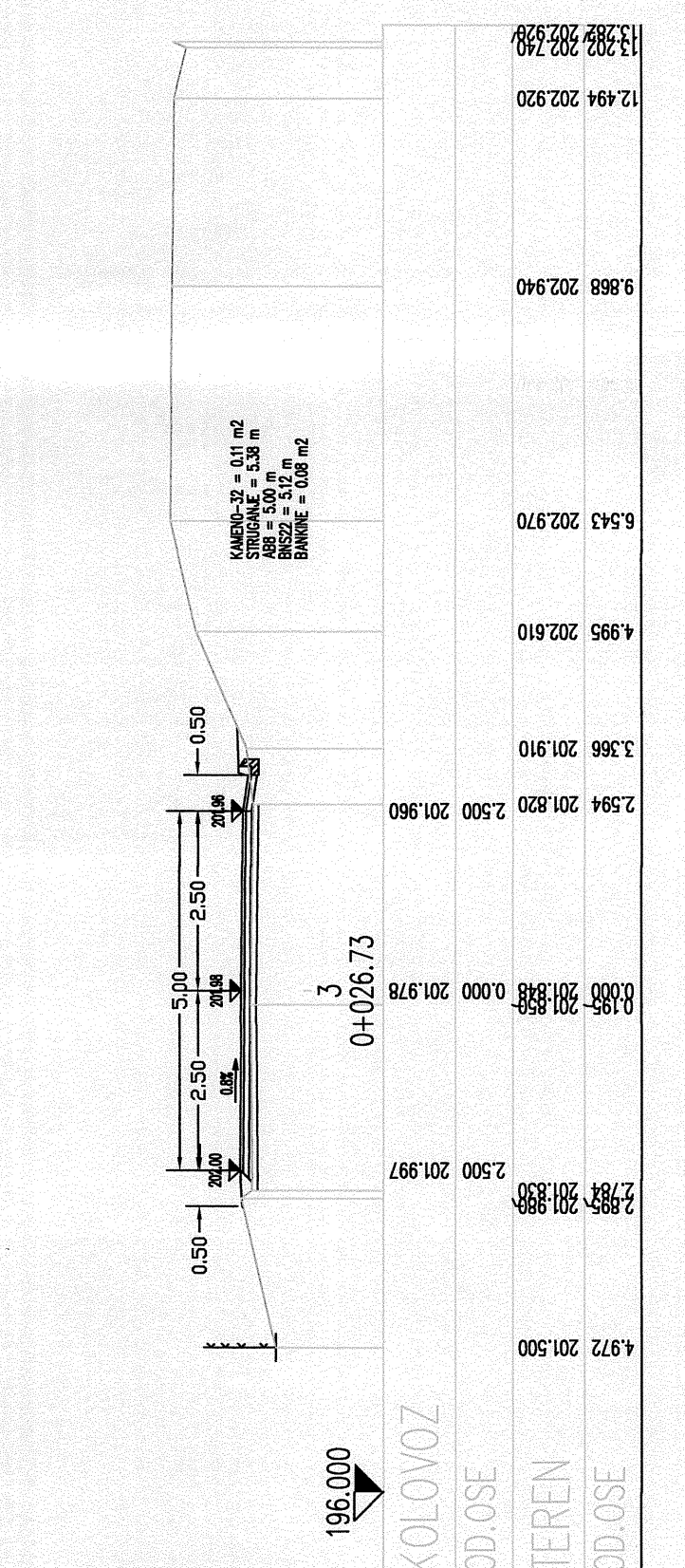

4.972	201.500	2.785	201.839	2.500	201.997	0.000	201.978	0.000	201.978	2.594	201.820	3.366	201.910	4.995	202.610	5.543	202.970	9.868	202.940
KOLOVOZ																			
OD.05E																			
TEREN																			
OD.05E																			

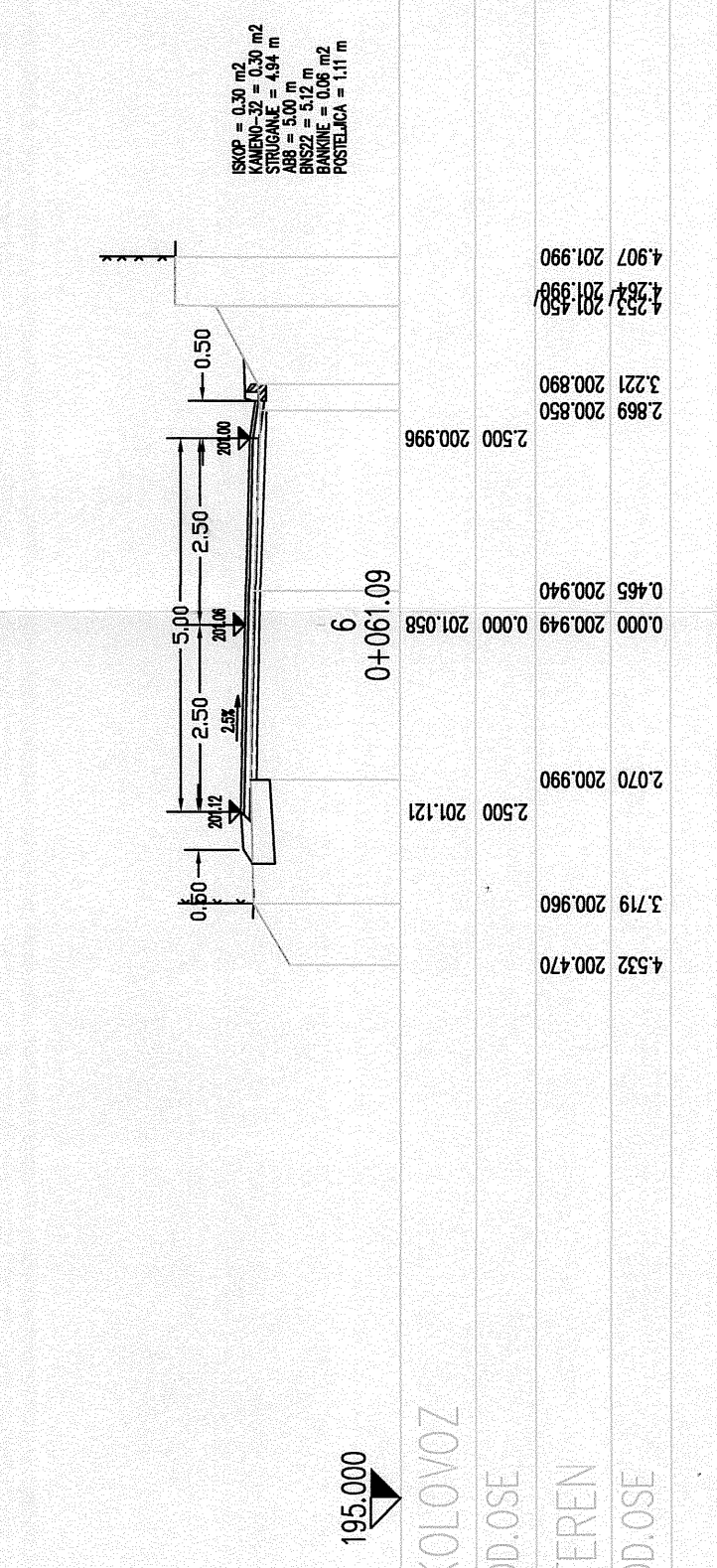

4.532	200.470	3.719	200.960	2.500	201.121	0.000	201.058	0.000	201.058	2.869	200.850	3.221	200.890	4.263	201.350	4.907	201.990
KOLOVOZ																	
OD.05E																	
TEREN																	
OD.05E																	

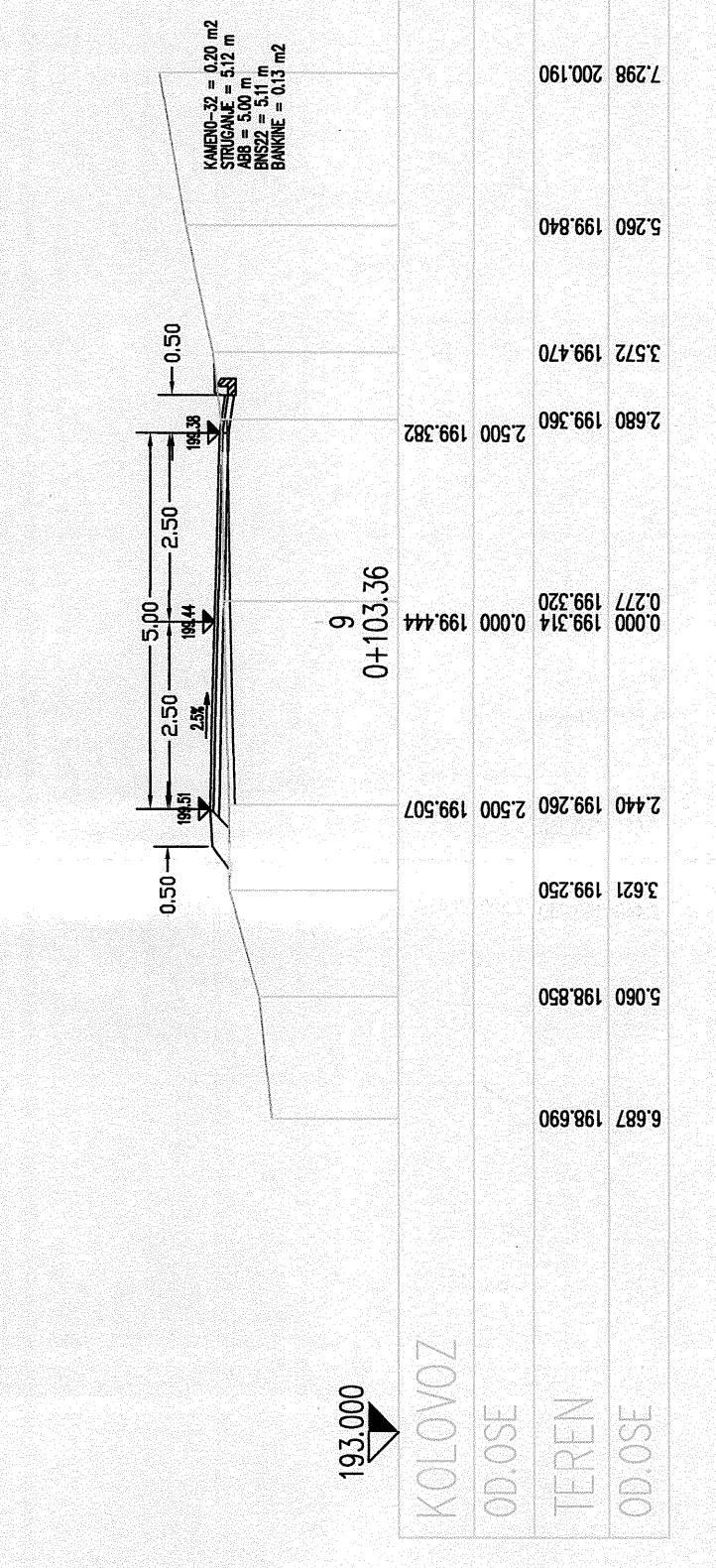

6.687	198.690	5.060	198.850	3.621	199.250	2.500	199.507	0.000	199.444	2.680	199.360	3.572	199.470	5.260	199.840	7.298	200.190
KOLOVOZ																	
OD.05E																	
TEREN																	
OD.05E																	

CPK - CENTAR ZA PUTEVE DOO
PREDUZEĆE
CPK

INVESTITOR: **OPŠTINA VARVARIN**
OBJEKT: **Opštinski put Zalogovac - Vratare**
NAZIV PROJEKTA: **GLAVNI PROJEKAT**

ODGOVORNI PROJEKTANT: **Borka Mladenović dipl.ing.grad.**
CRTEŽ: **Poprečni profili od km 0+002.54 do km 0+139.35**
RAZMERA: **R - 1:100**

LIST BR. **1**
08.2012.

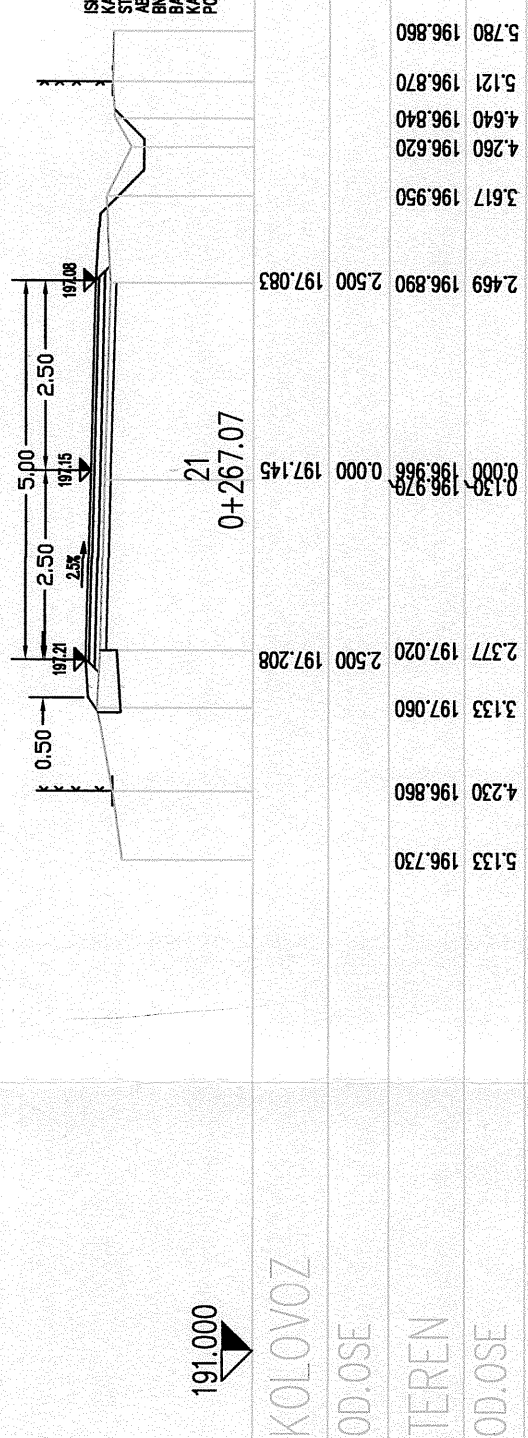

5.780	196.860	0.000	196.860	2.500	197.020	2.500	197.208	0.000	197.145	0+267.07
5.121	196.870	0.000	196.870	2.500	197.020	2.500	197.208	0.000	197.145	0+267.07
4.280	196.620	0.000	196.620	2.500	197.020	2.500	197.208	0.000	197.145	0+267.07
3.617	196.950	0.000	196.950	2.500	197.020	2.500	197.208	0.000	197.145	0+267.07
2.469	196.890	0.000	196.890	2.500	197.020	2.500	197.208	0.000	197.145	0+267.07
1.910	196.890	0.000	196.890	2.500	197.020	2.500	197.208	0.000	197.145	0+267.07

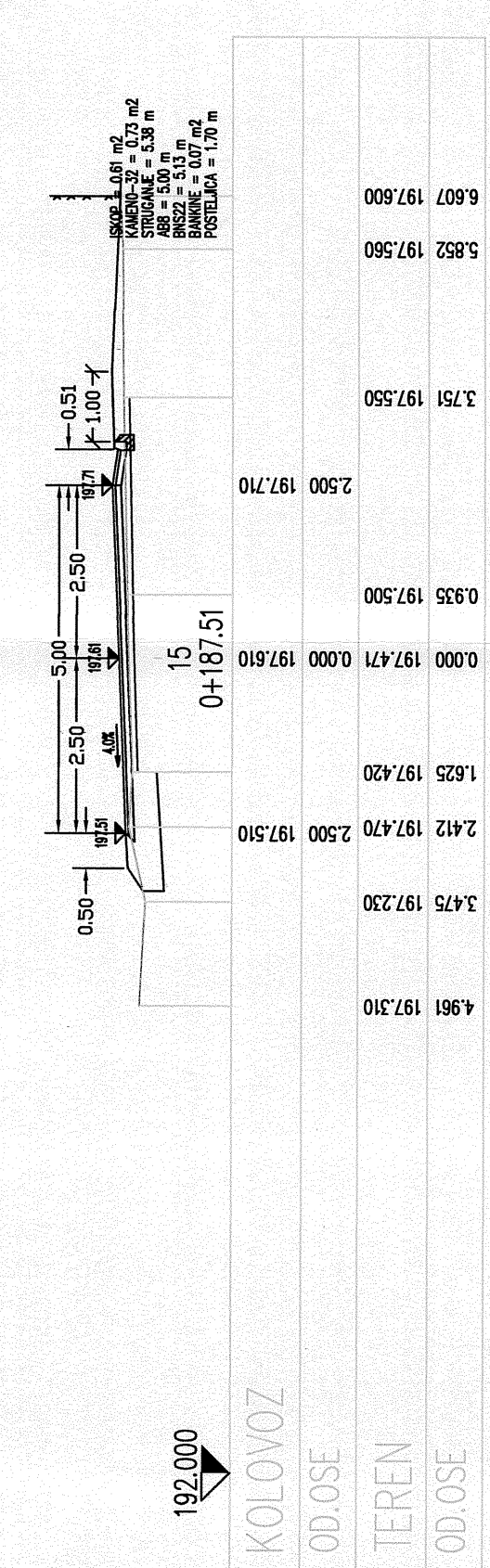

5.682	197.210	0.000	197.210	2.500	197.510	2.500	197.310	0.000	197.410	0+221.52
3.163	197.310	0.000	197.310	2.500	197.280	2.500	197.510	0.000	197.410	0+221.52
2.168	197.280	0.000	197.280	2.500	197.280	2.500	197.510	0.000	197.410	0+221.52
1.882	197.420	0.000	197.420	2.500	197.500	2.500	197.510	0.000	197.510	0+221.52
0.935	197.500	0.000	197.500	2.500	197.500	2.500	197.510	0.000	197.510	0+221.52
0.000	197.470	0.000	197.470	2.500	197.470	2.500	197.510	0.000	197.510	0+221.52

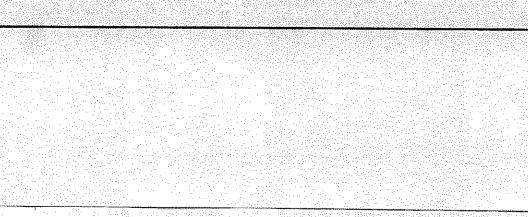

5.852	197.560	0.000	197.560	2.500	197.710	2.500	197.510	0.000	197.610	0+187.51
3.751	197.550	0.000	197.550	2.500	197.710	2.500	197.510	0.000	197.610	0+187.51
1.625	197.420	0.000	197.420	2.500	197.420	2.500	197.510	0.000	197.610	0+187.51
2.412	197.470	0.000	197.470	2.500	197.470	2.500	197.510	0.000	197.610	0+187.51
3.475	197.230	0.000	197.230	2.500	197.230	2.500	197.510	0.000	197.610	0+187.51
4.961	197.310	0.000	197.310	2.500	197.310	2.500	197.510	0.000	197.610	0+187.51

5.882	197.620	0.000	197.620	2.500	198.139	2.500	198.139	0.000	198.170	0+152.41
4.043	197.620	0.000	197.620	2.500	198.139	2.500	198.139	0.000	198.170	0+152.41
3.364	197.890	0.000	197.890	2.500	198.139	2.500	198.139	0.000	198.170	0+152.41
2.375	197.920	0.000	197.920	2.500	198.139	2.500	198.139	0.000	198.170	0+152.41
0.782	198.076	0.000	198.076	2.500	198.139	2.500	198.139	0.000	198.170	0+152.41
0.000	198.076	0.000	198.076	2.500	198.139	2.500	198.139	0.000	198.170	0+152.41

6.130	197.410	0.000	197.410	2.500	197.788	2.500	197.890	0.000	197.890	0+165.43
3.970	197.360	0.000	197.360	2.500	197.788	2.500	197.890	0.000	197.890	0+165.43
3.411	197.610	0.000	197.610	2.500	197.788	2.500	197.890	0.000	197.890	0+165.43
2.030	197.630	0.000	197.630	2.500	197.788	2.500	197.890	0.000	197.890	0+165.43
0.228	197.700	0.000	197.700	2.500	197.788	2.500	197.890	0.000	197.890	0+165.43
0.000	197.683	0.000	197.683	2.500	197.788	2.500	197.890	0.000	197.890	0+165.43

4.135	197.220	0.000	197.220	2.500	197.540	2.500	197.540	0.000	197.474	0+210.58
3.056	197.220	0.000	197.220	2.500	197.540	2.500	197.540	0.000	197.474	0+210.58
2.198	197.310	0.000	197.310	2.500	197.540	2.500	197.540	0.000	197.474	0+210.58
0.407	197.290	0.000	197.290	2.500	197.474	2.500	197.474	0.000	197.474	0+210.58
0.000	197.293	0.000	197.293	2.500	197.474	2.500	197.474	0.000	197.474	0+210.58
0.000	197.220	0.000	197.220	2.500	197.474	2.500	197.474	0.000	197.474	0+210.58

5.099	197.260	0.000	197.260	2.500	197.443	2.500	197.443	0.000	197.543	0+198.71
3.277	197.360	0.000	197.360	2.500	197.443	2.500	197.443	0.000	197.543	0+198.71
2.218	197.390	0.000	197.390	2.500	197.443	2.500	197.443	0.000	197.543	0+198.71
0.252	197.430	0.000	197.430	2.500	197.443	2.500	197.443	0.000	197.543	0+198.71
0.000	197.426	0.000	197.426	2.500	197.443	2.500	197.443	0.000	197.543	0+198.71
0.000	197.320	0.000	197.320	2.500	197.443	2.500	197.443	0.000	197.543	0+198.71

5.967	196.960	0.000	196.960	2.500	197.219	2.500	197.219	0.000	197.319	0+237.22
3.851	196.950	0.000	196.950	2.500	197.219	2.500	197.219	0.000	197.319	0+237.22
3.112	197.080	0.000	197.080	2.500	197.219	2.500	197.219	0.000	197.319	0+237.22
2.134	197.120	0.000	197.120	2.500	197.219	2.500	197.219	0.000	197.319	0+237.22
0.289	197.076	0.000	197.076	2.500	197.219	2.500	197.219	0.000	197.319	0+237.22
0.000	197.076	0.000	197.076	2.500	197.219	2.500	197.219	0.000	197.319	0+237.22

9.525	196.730	0.000	196.730	2.500	197.144	2.500	197.144	0.000	197.237	0+251.28
4.035	196.870	0.000	196.870	2.500	197.144	2.500	197.144	0.000	197.237	0+251.28
3.042	197.030	0.000	197.030	2.500	197.144	2.500	197.144	0.000	197.237	0+251.28
2.208	197.010	0.000	197.010	2.500	197.144	2.500	197.144	0.000	197.237	0+251.28
0.000	197.028	0.000	197.028	2.500	197.144	2.500	197.144	0.000	197.237	0+251.28
0.000	197.028	0.000	197.028	2.500	197.144	2.500	197.144	0.000	197.237	0+251.28

4.789	196.810	0.000	196.810	2.500	197.103	2.500	197.103	0.000	197.041	0+285.10
4.073	196.830	0.000	196.830	2.500	197.103	2.500	197.103	0.000	197.041	0+285.10
2.261	196.870	0.000	196.870	2.500	197.103	2.500	197.103	0.000	197.041	0+285.10
0.000	196.841	0.000	196.841	2.500	197.041	2.500	197.041	0.000	197.041	0+285.10
0.000	196.841	0.000	196.841	2.500	197.041	2.500	197.041	0.000	197.041	0+285.10
0.000	196.841	0.000	196.841	2.500	197.041	2.500	197.041	0.000	197.041	0+285.10

4.666	197.310	0.000	197.310	2.500	197.730	2.500	197.730	0.000	197.730	0+175.63
3.457	197.250	0.000	197.250	2.500	197.730	2.500	197.730	0.000	197.730	0+175.63
2.790	197.510	0.000	197.510	2.500	197.730	2.500	197.730	0.000	197.730	0+175.63
1.869	197.500	0.000	197.500	2.500	197.730	2.500	197.730	0.000	197.730	0+175.63
0.645	197.610	0.000	197.610	2.500	197.730	2.500	197.730	0.000	197.730	0+175.63
0.000	197.582	0.000	197.582	2.500	197.730	2.500	197.730	0.000	197.730	0+175.63

5.473	197.640	0.000	197.640	2.500	197.992	2.500	197.992	0.000	197.890	0+152.41
4.723	197.680	0.000	197.680	2.500	197.992	2.500	197.992	0.000	197.890	0+152.41
2.939	197.810	0.000	197.810	2.500	197.992	2.500	197.992	0.000	197.890	0+152.41
0.228	197.700	0.000	197.700	2.500	197.890	2.500	197.890	0.000	197.890	0+152.41
0.000	197.683	0.000	197.683	2.500	197.890	2.500	197.890	0.000	197.890	0+152.41
0.000	197.683	0.000	197.683	2.500	197.890	2.500	197.890	0.000	197.890	0+152.41

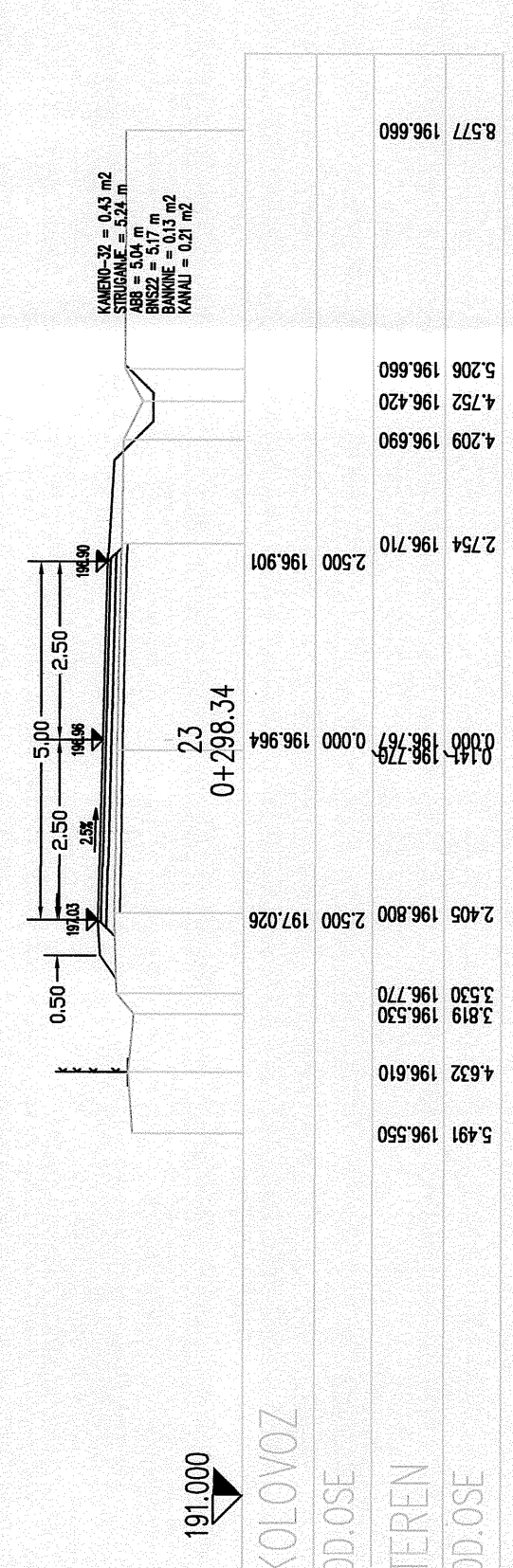

5.491	196.550
4.632	196.610
3.819	196.530
3.530	196.770
2.405	196.800
2.500	196.901
2.754	196.710
4.209	196.690
4.752	196.430
5.206	196.660
8.577	196.660

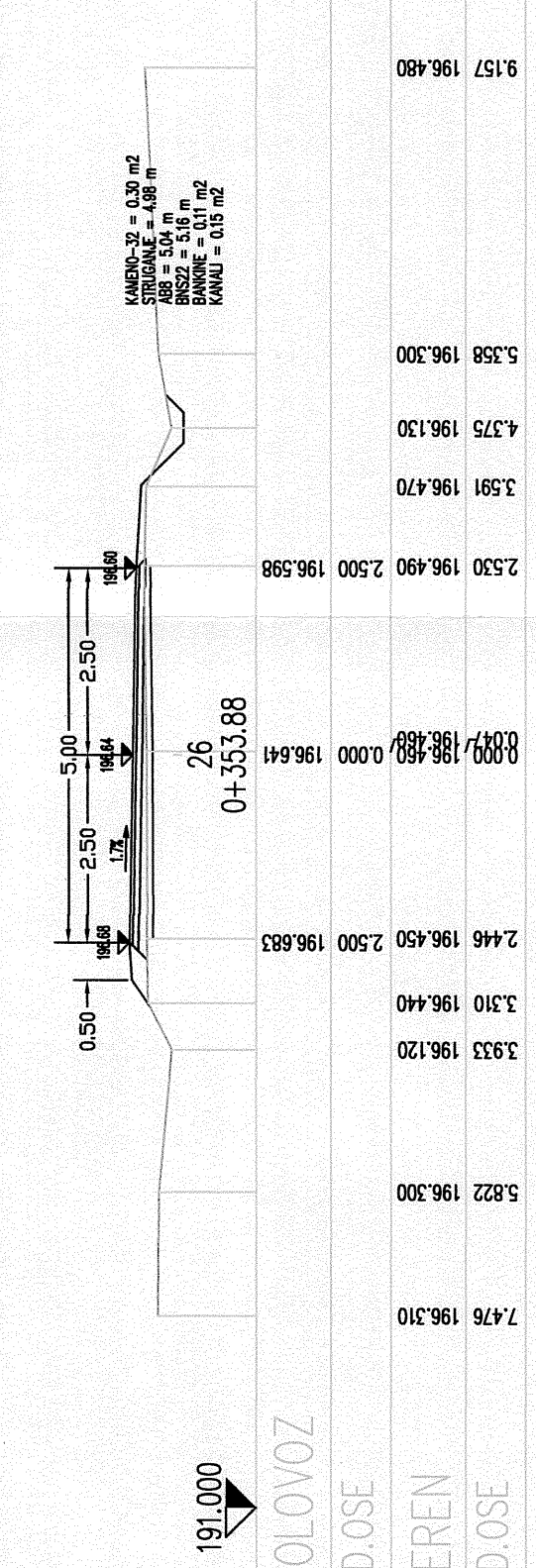

7.476	196.310
5.822	196.300
3.933	196.120
3.310	196.440
2.446	196.450
2.500	196.683
2.530	196.490
3.591	196.470
4.375	196.130
5.358	196.300
9.157	196.480

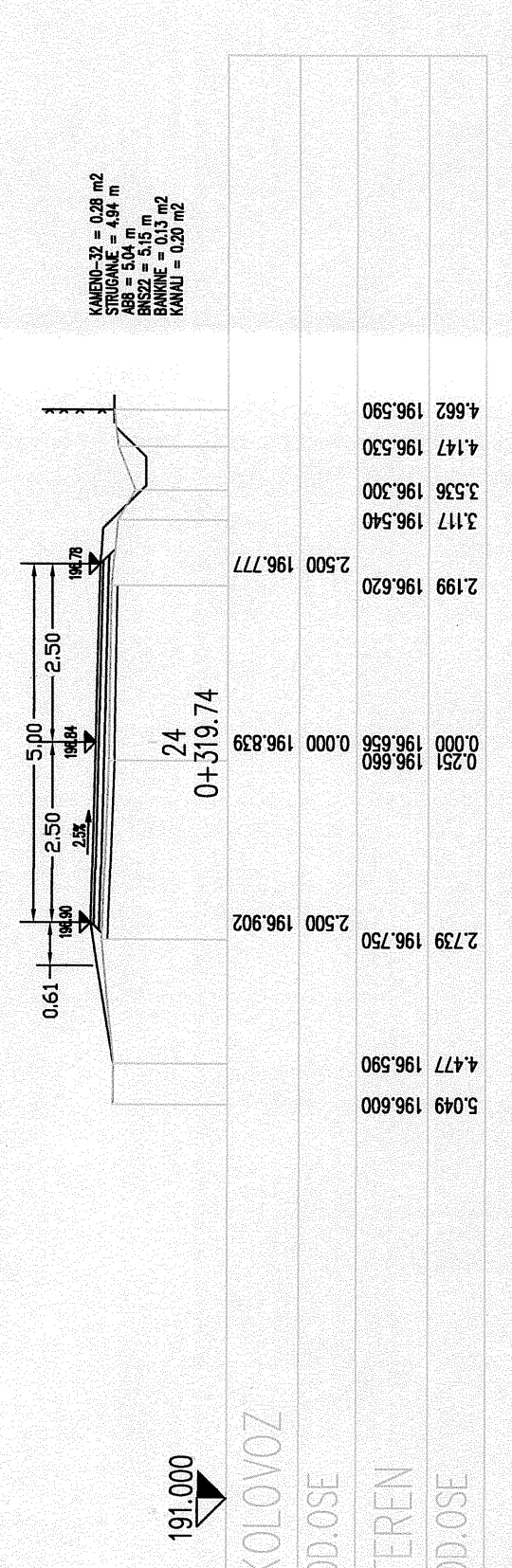

5.049	196.600
4.477	196.590
2.739	196.750
2.500	196.902
196.777	2.500
3.117	196.540
3.336	196.300
4.147	196.530
4.662	196.590
8.671	196.300

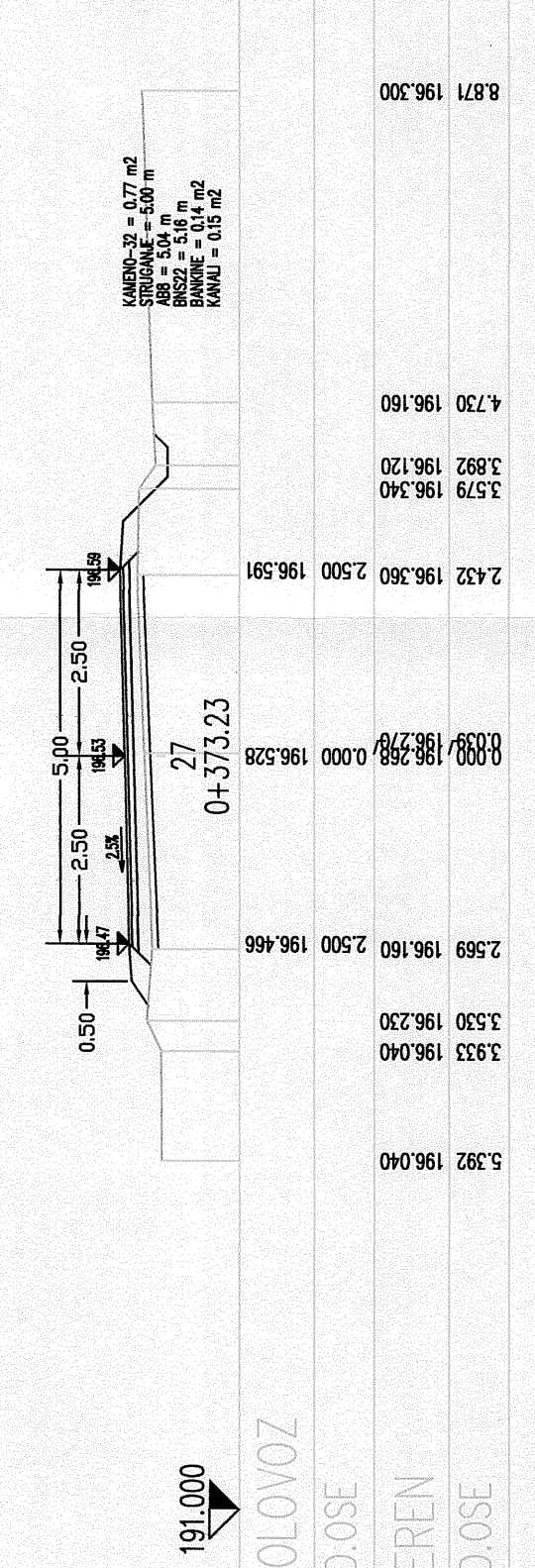

5.392	196.040
3.933	196.040
3.530	196.230
2.569	196.160
2.432	196.360
2.500	196.591
0.000	196.278
0.000	196.528
3.579	196.340
3.892	196.120
4.730	196.160
8.671	196.300

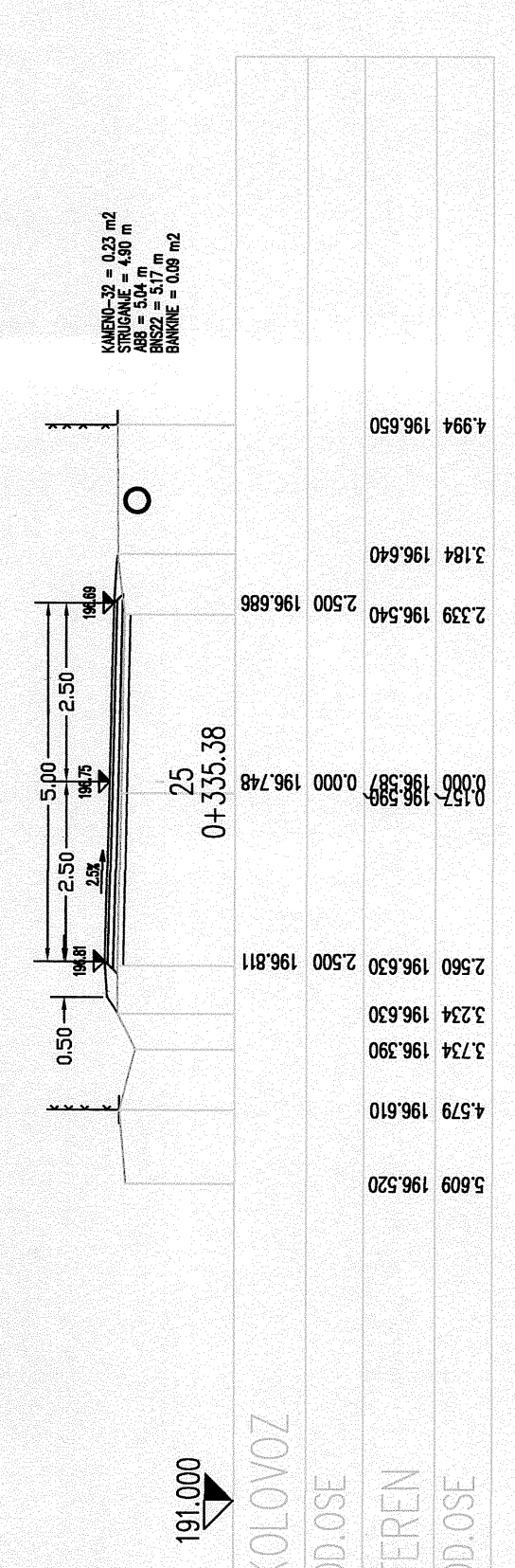

5.609	196.520
4.579	196.610
3.734	196.630
2.560	196.630
2.500	196.811
2.500	196.748
2.339	196.540
3.184	196.640
3.184	196.640
4.994	196.650

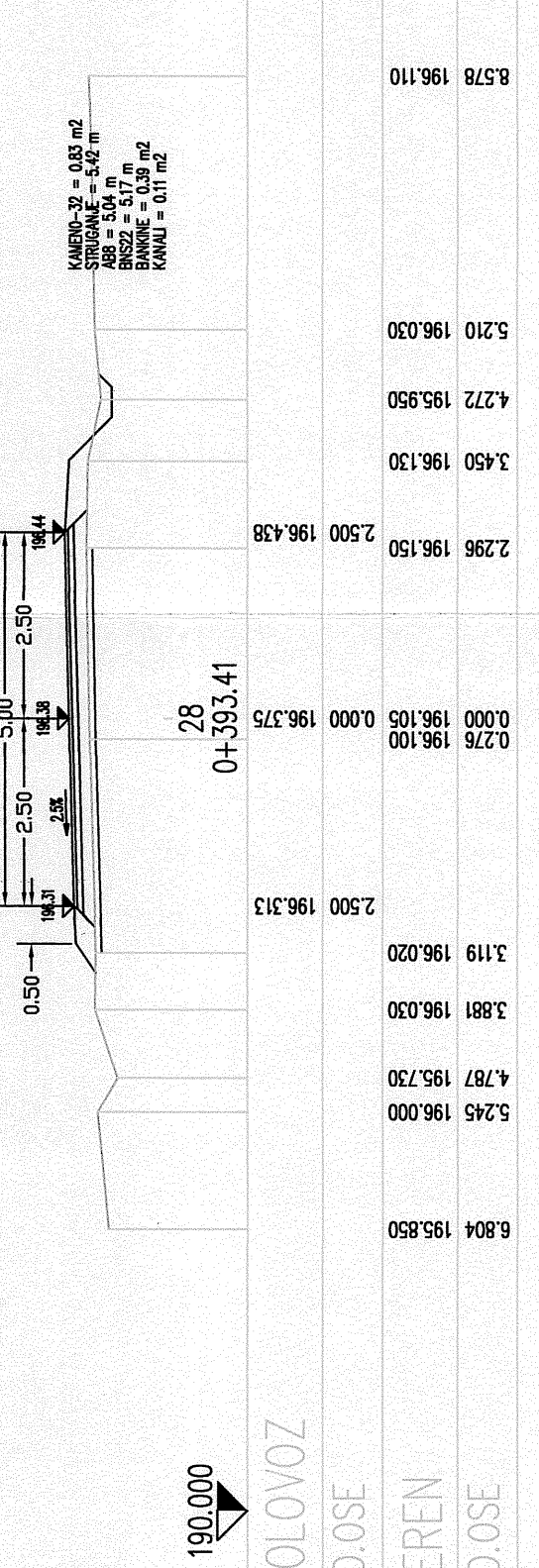

6.804	195.850
5.245	196.000
4.787	195.730
3.881	196.030
3.119	196.020
2.500	196.313
0.000	196.375
0.000	196.375
2.296	196.150
3.450	196.130
4.272	195.950
5.210	196.030
8.578	196.110

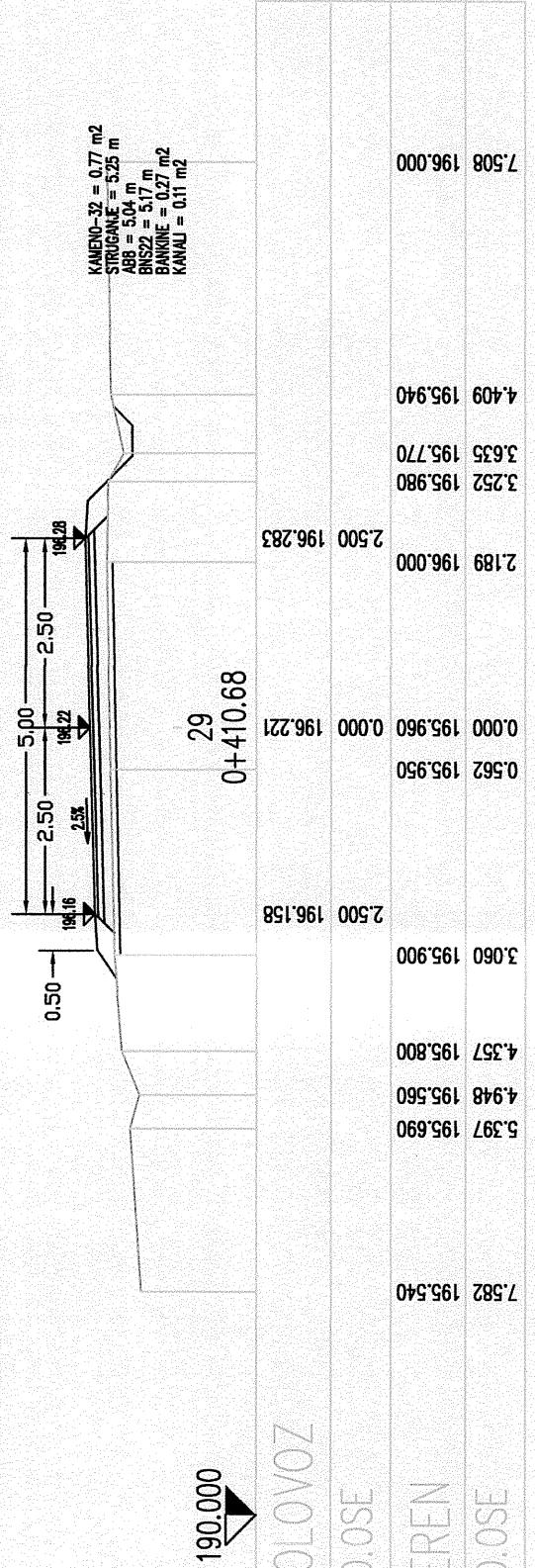

7.582	195.540
5.397	195.690
4.948	195.560
4.357	195.800
3.060	195.900
2.500	196.158
0.000	195.960
0.562	195.950
2.189	196.000
2.500	196.283
3.635	195.770
4.409	195.940
7.508	196.000

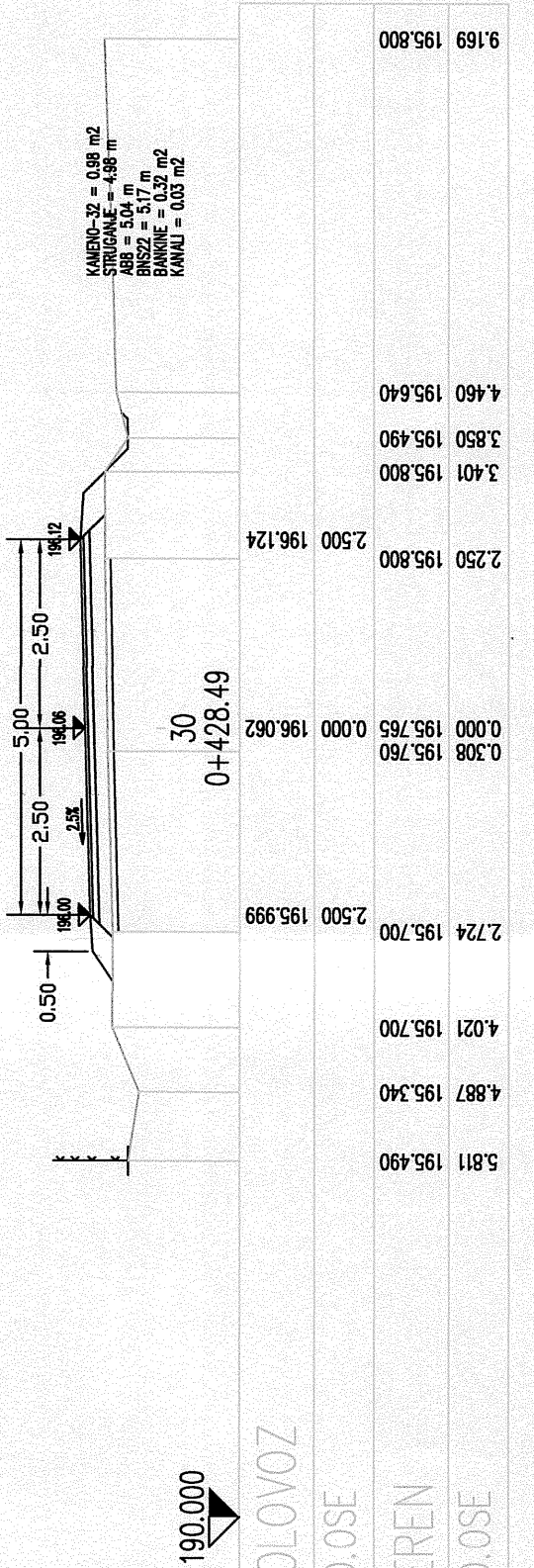

5.811	195.490
4.887	195.340
4.021	195.700
2.724	195.700
2.500	195.999
0.000	196.062
0.308	195.760
0.000	195.765
2.250	196.800
2.250	196.124
3.401	195.800
3.850	195.490
4.460	195.640
9.169	195.800



6.345	195.070
4.503	194.920
3.890	195.290
2.641	195.260
2.500	195.542
0.298	195.300
0.000	195.308
0.000	195.605
2.266	195.370
2.500	195.667
3.550	195.310
4.225	195.040
4.916	195.360
8.223	195.550

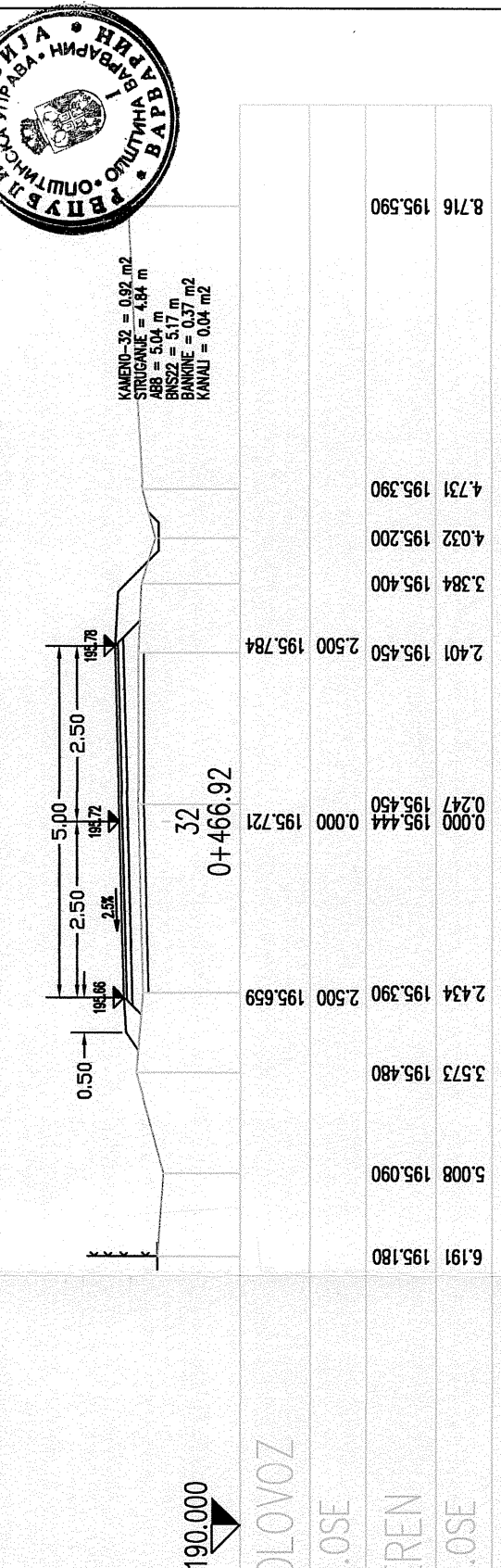

6.191	195.180
5.008	195.090
3.573	195.480
2.434	195.390
2.500	195.659
0.271	195.450
0.000	195.444
0.000	195.721
2.401	195.450
2.500	195.784
3.384	195.400
4.032	195.200
4.731	195.390
8.716	195.590

CPK - CENTAR ZA PUTEVE DOO
KRUŠEVAC

INVESTITOR: **OPŠTINA VARVARIN**
ODREČAT: **Opštinski put Zalogovac - Vratara**
NAZIV PROJEKTA: **GLAVNI PROJEKAT**

ODGOVORNI PROJEKTANT: **Borka Mladenović dipl.ing.građ.**

CRTEŽ: **Poprečni profili od km 0+298.34 do km 0+489.94**
KAZIMERA: **R - 1:100**

LIST BR. **3**

08.2012.

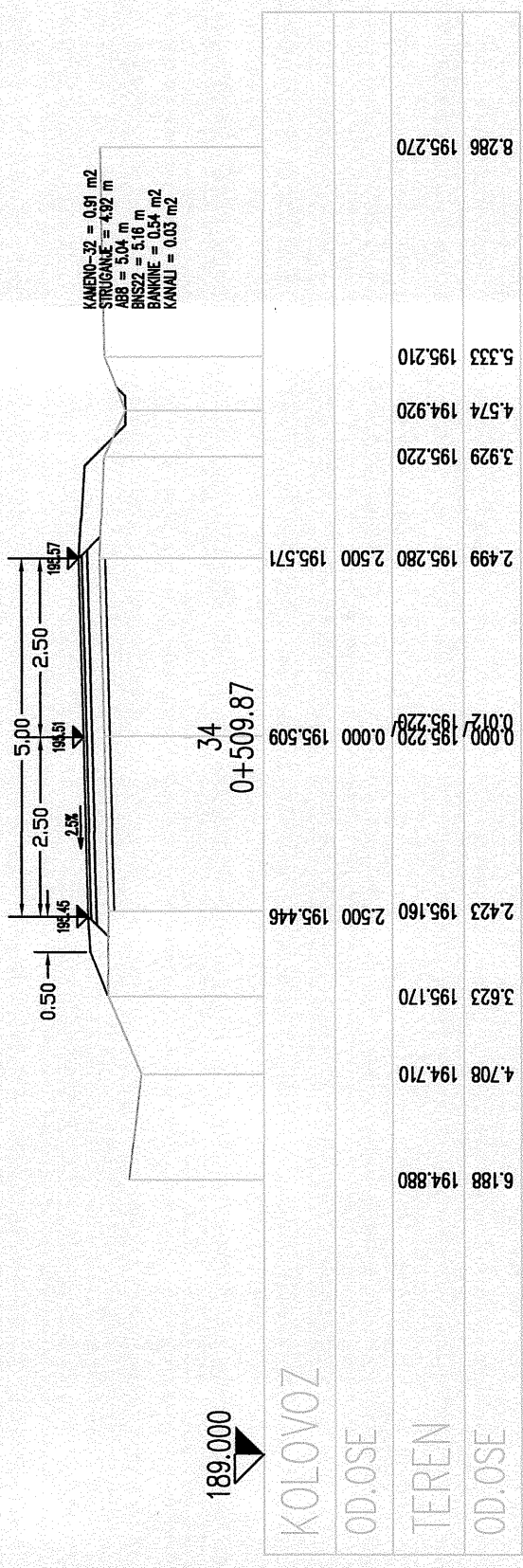

6.188	194.880	4.708	194.710	3.623	195.170	2.423	195.160	2.500	195.446	0.000	195.509	2.499	195.280	2.500	195.571	3.929	195.220	4.574	194.920	5.333	195.210	8.286	195.270
											189.000												
											KOLOVOZ												
											OD.0SE												
											TEREN												
											OD.0SE												

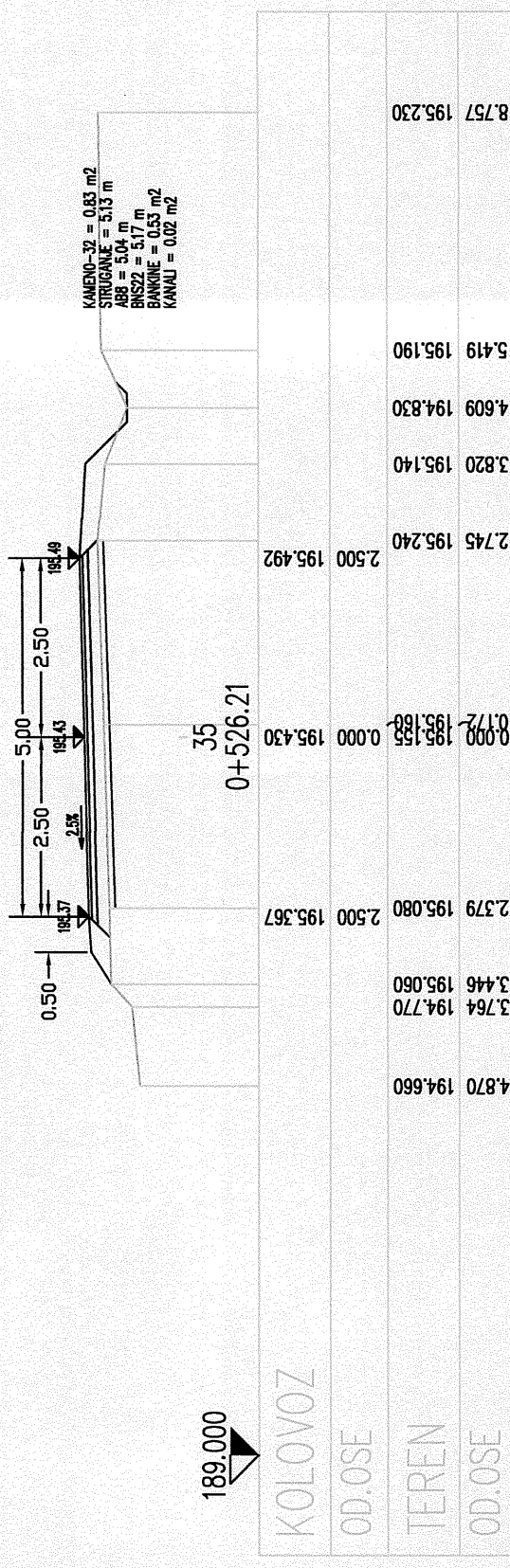

4.870	194.660	3.466	194.770	3.746	195.060	2.379	195.080	2.500	195.367	0.000	195.430	2.745	195.240	2.500	195.492	3.820	195.140	4.609	194.830	5.419	195.190	8.757	195.230
											189.000												
											KOLOVOZ												
											OD.0SE												
											TEREN												
											OD.0SE												

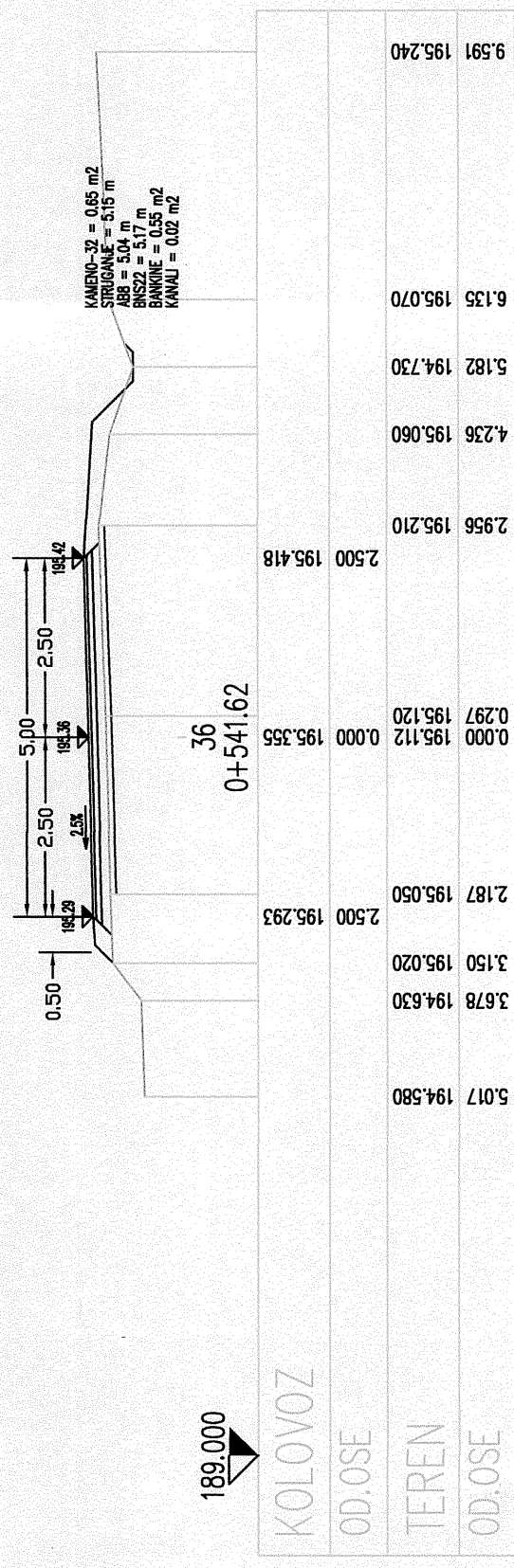

5.017	194.580	3.678	194.630	3.150	195.020	2.187	195.050	2.500	195.293	0.000	195.355	2.500	195.418	2.500	195.418	2.956	195.210	4.236	195.060	5.182	194.730	6.135	195.070	9.591	195.240
											189.000														
											KOLOVOZ														
											OD.0SE														
											TEREN														
											OD.0SE														

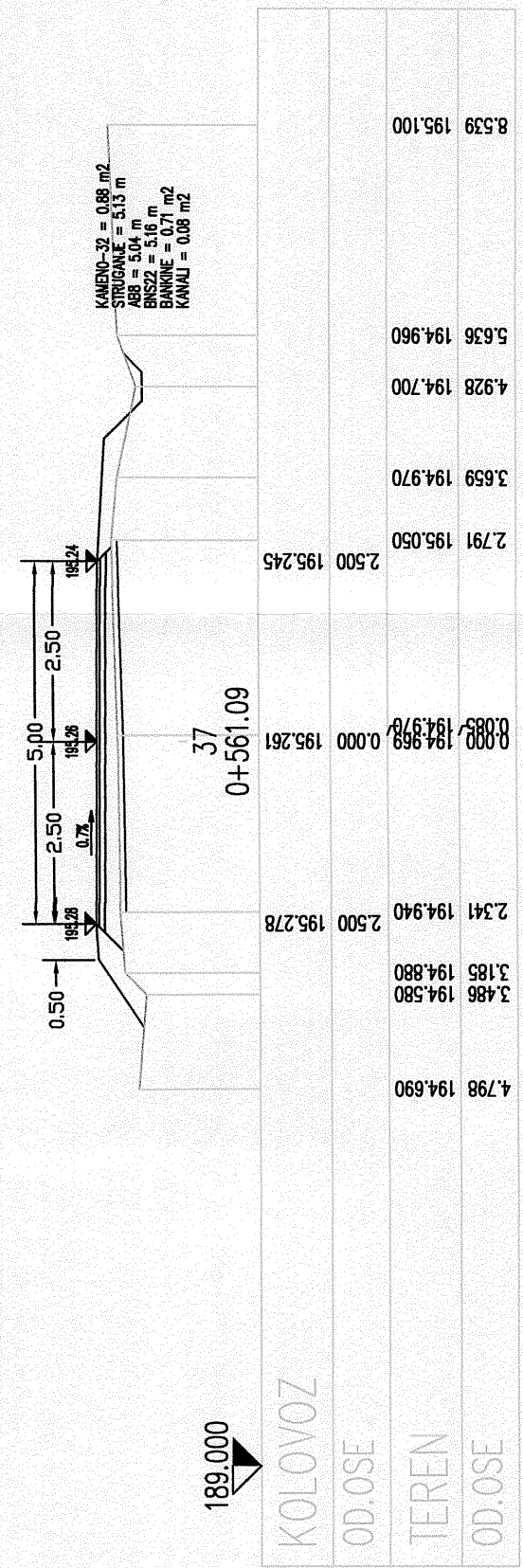

4.798	194.690	3.185	194.580	3.185	194.880	2.341	194.940	2.500	195.278	0.000	195.261	2.791	195.050	2.500	195.245	3.659	194.970	4.928	194.700	5.636	194.960	8.539	195.100
											189.000												
											KOLOVOZ												
											OD.0SE												
											TEREN												
											OD.0SE												

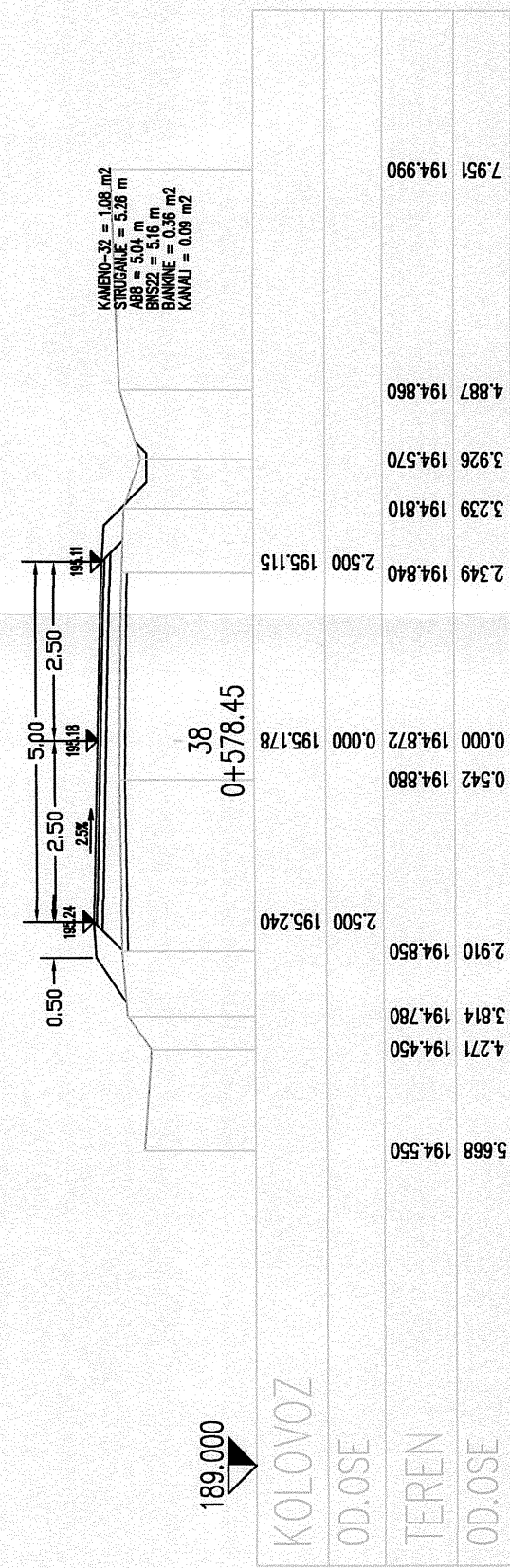

5.688	194.550	4.271	194.450	3.814	194.780	2.910	194.850	2.500	195.240	0.000	195.178	2.349	194.840	2.500	195.115	3.239	194.810	4.887	194.860	7.951	194.990	
											189.000											
											KOLOVOZ											
											OD.0SE											
											TEREN											
											OD.0SE											

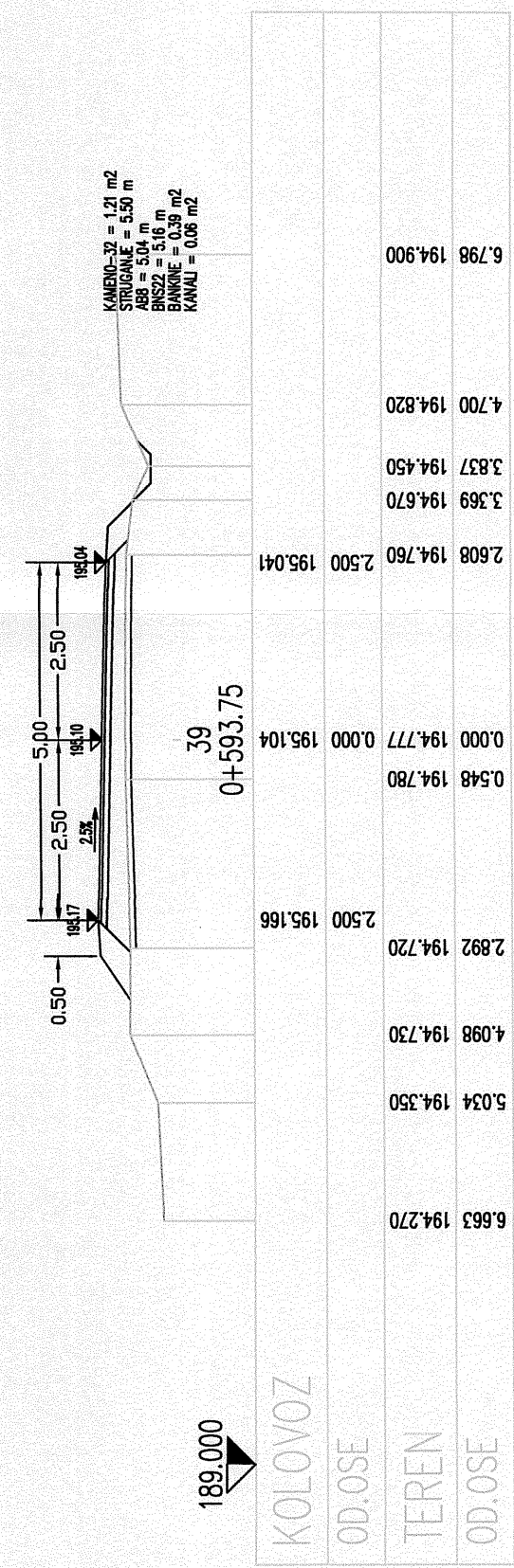

6.663	194.270	5.034	194.350	4.098	194.730	2.892	194.720	2.500	195.166	0.000	195.104	2.608	194.760	2.500	195.041	3.369	194.670	4.700	194.820	6.798	194.900	
											189.000											
											KOLOVOZ											
											OD.0SE											
											TEREN											
											OD.0SE											

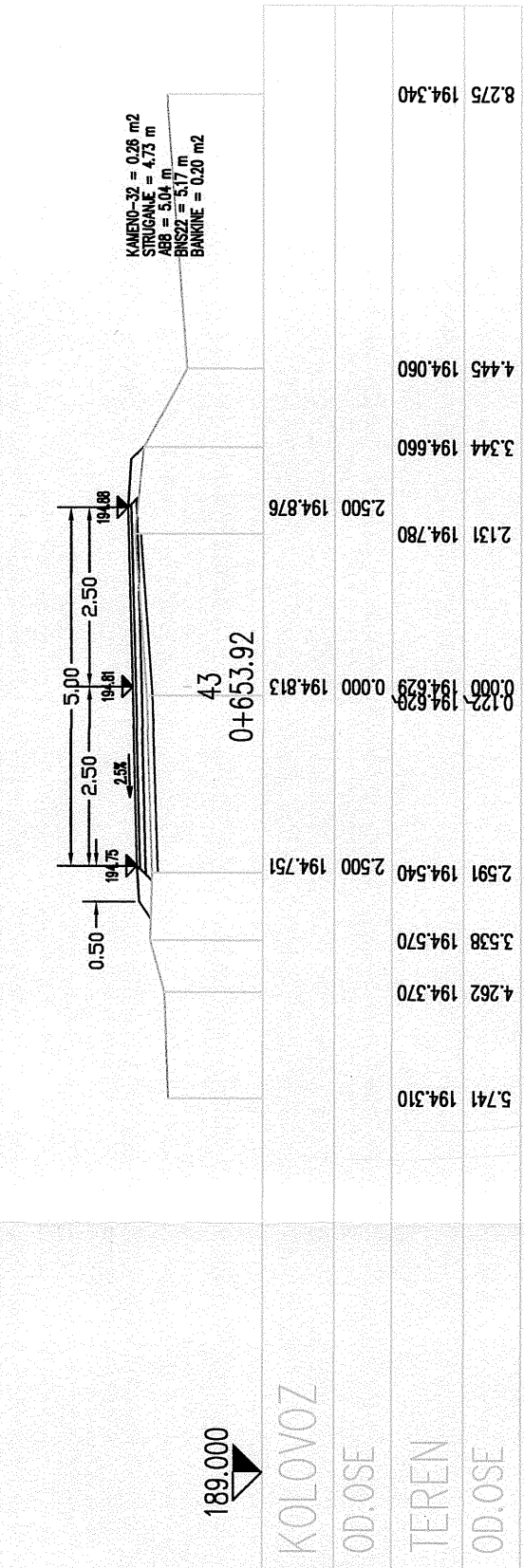

5.741	194.310	4.262	194.370	3.538	194.570	2.591	194.540	2.500	194.751	0.000	194.813	2.131	194.780	2.500	194.876	3.344	194.660	4.445	194.060	8.275	194.340	
											189.000											
											KOLOVOZ											
											OD.0SE											
											TEREN											
											OD.0SE											

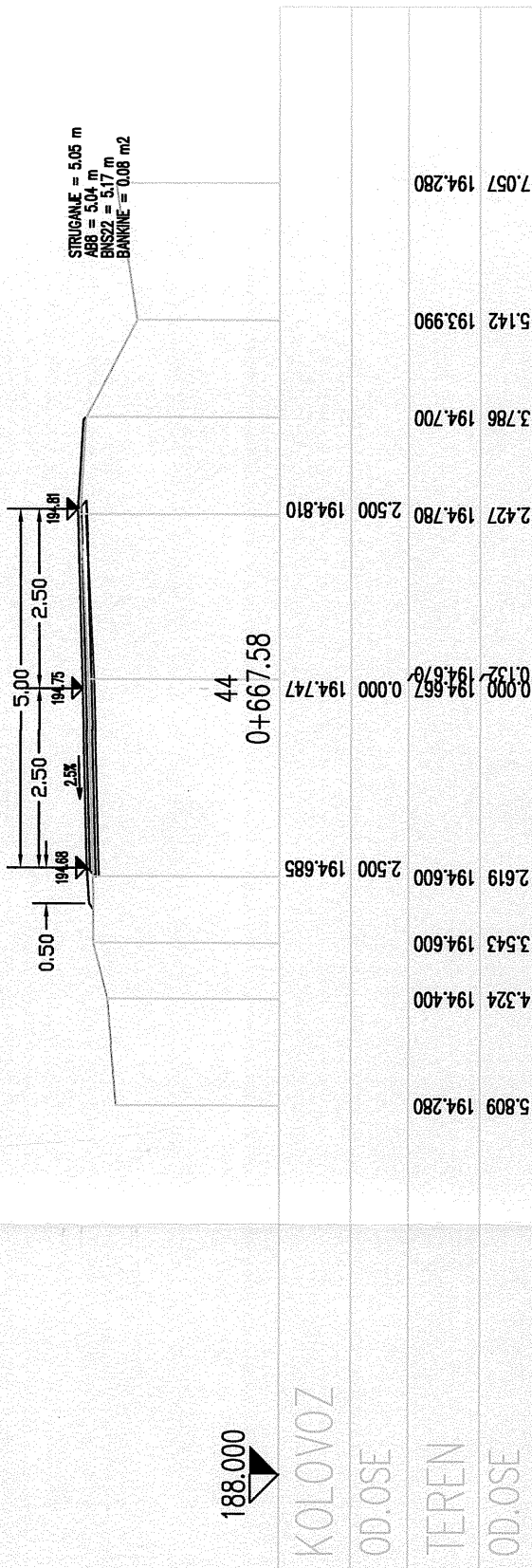

5.809	194.280	4.324	194.400	3.543	194.600	2.619	194.600	2.500	194.685	0.000	194.747	2.427	194.780	2.500	194.810	3.786	194.700	5.142	193.990	7.057	194.280	
											188.000											
											KOLOVOZ											
											OD.0SE											
											TEREN											
											OD.0SE											

CPK - CENTAR ZA PUTEVE DOO

CPK

INVESTITOR: **OPŠTINA VARVARIN**

OBJEKAT: **Opštinski put Zalogovac - Vratare**

NAZIV PROJEKTA: **GLAVNI PROJEKAT**

ODGOVORNI PROJEKTANT: **Borka Mladenović dipl.ing.grad.**

CRTEŽ: **Poprečni profili od km 0+509.87 do km 0+667.58**

RAZINA: **R - 1:100**

LIST BR. **4**

08.2012.

11.468	194.450	5.773	194.230	4.307	194.390	3.391	194.520	2.365	194.510	2.500	194.816	2.305	194.780	2.500	194.941	3.412	194.660	4.419	194.110	6.898	194.320	
											189.000											
											KOLOVOZ											
											OD.0SE											
											TEREN											
											OD.0SE											



5.589	192.980	5.520	192.980	4.520	193.310	3.544	193.310	2.468	193.340	2.500	193.581	0.000	193.644	0.000	193.408	2.500	193.708	2.662	193.460	3.577	193.360	4.663	192.980	5.522	193.020	7.546	193.100
-------	---------	-------	---------	-------	---------	-------	---------	-------	---------	-------	---------	-------	---------	-------	---------	-------	---------	-------	---------	-------	---------	-------	---------	-------	---------	-------	---------

187.000
KOLOVOZ
OD.0SE
TEREN
OD.0SE

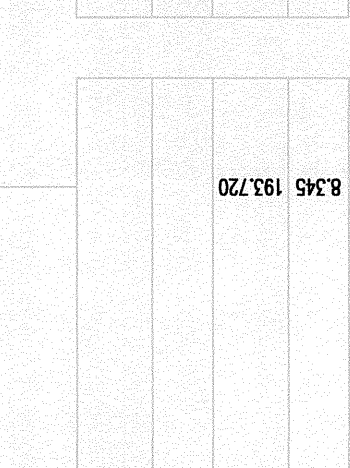

5.150	193.590	3.910	193.640	3.326	193.850	2.624	193.830	2.500	194.097	0.000	193.878	0.000	194.159	2.500	193.970	2.406	193.970	2.406	193.970	3.273	193.910	4.255	193.600	8.345	193.720
-------	---------	-------	---------	-------	---------	-------	---------	-------	---------	-------	---------	-------	---------	-------	---------	-------	---------	-------	---------	-------	---------	-------	---------	-------	---------

188.000
KOLOVOZ
OD.0SE
TEREN
OD.0SE

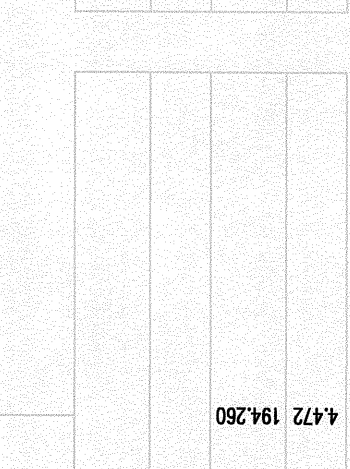

4.978	193.850	3.744	193.870	3.234	194.060	2.354	194.030	2.500	194.360	0.000	194.336	0.000	194.336	2.500	194.312	2.761	194.190	3.954	194.290	5.799	194.370
-------	---------	-------	---------	-------	---------	-------	---------	-------	---------	-------	---------	-------	---------	-------	---------	-------	---------	-------	---------	-------	---------

188.000
KOLOVOZ
OD.0SE
TEREN
OD.0SE

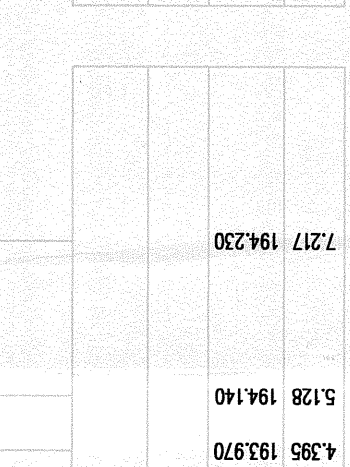

6.326	193.880	4.733	193.990	3.782	194.420	2.712	194.490	2.500	194.657	0.000	194.595	0.000	194.595	2.500	194.532	2.919	194.290	3.539	194.280	4.209	193.830	4.705	193.980	7.601	194.320
-------	---------	-------	---------	-------	---------	-------	---------	-------	---------	-------	---------	-------	---------	-------	---------	-------	---------	-------	---------	-------	---------	-------	---------	-------	---------

188.000
KOLOVOZ
OD.0SE
TEREN
OD.0SE

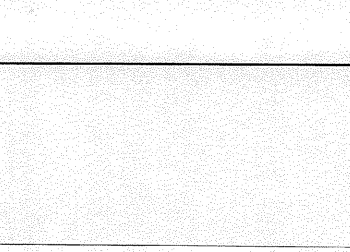

6.059	193.570	4.449	193.430	3.742	194.260	2.614	194.310	2.500	194.580	0.000	194.517	0.000	194.289	2.500	194.260	2.505	194.260	3.292	194.230	4.252	193.710	4.759	193.370	6.049	193.870
-------	---------	-------	---------	-------	---------	-------	---------	-------	---------	-------	---------	-------	---------	-------	---------	-------	---------	-------	---------	-------	---------	-------	---------	-------	---------

188.000
KOLOVOZ
OD.0SE
TEREN
OD.0SE

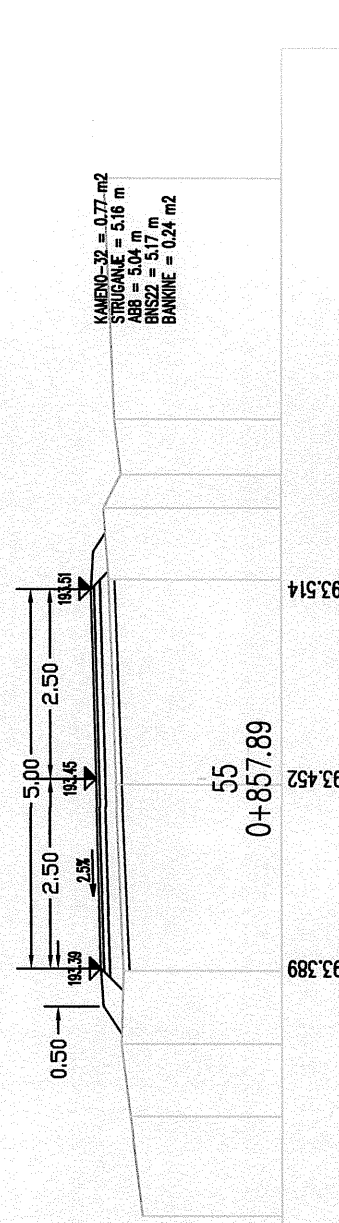

5.766	192.840	4.453	193.000	3.493	193.120	2.530	193.090	2.500	193.389	0.000	193.452	0.000	193.452	2.500	193.514	2.627	193.280	3.572	193.360	4.015	193.120	4.748	193.210	7.931	193.360
-------	---------	-------	---------	-------	---------	-------	---------	-------	---------	-------	---------	-------	---------	-------	---------	-------	---------	-------	---------	-------	---------	-------	---------	-------	---------

187.000
KOLOVOZ
OD.0SE
TEREN
OD.0SE

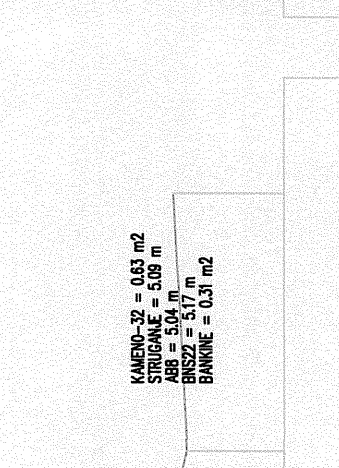

6.148	193.220	4.463	193.280	3.521	193.600	2.587	193.680	2.500	193.919	0.000	193.748	0.000	193.981	2.504	193.810	2.504	193.810	3.396	193.700	5.118	193.280	8.519	193.460
-------	---------	-------	---------	-------	---------	-------	---------	-------	---------	-------	---------	-------	---------	-------	---------	-------	---------	-------	---------	-------	---------	-------	---------

188.000
KOLOVOZ
OD.0SE
TEREN
OD.0SE

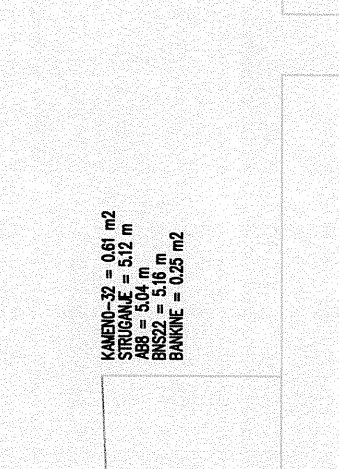

5.508	193.020	4.248	193.230	3.535	193.570	2.501	193.520	2.500	193.751	0.000	193.814	0.000	193.814	2.500	193.876	2.698	193.630	3.849	193.410	4.657	193.090	5.416	193.590	9.050	193.590
-------	---------	-------	---------	-------	---------	-------	---------	-------	---------	-------	---------	-------	---------	-------	---------	-------	---------	-------	---------	-------	---------	-------	---------	-------	---------

188.000
KOLOVOZ
OD.0SE
TEREN
OD.0SE

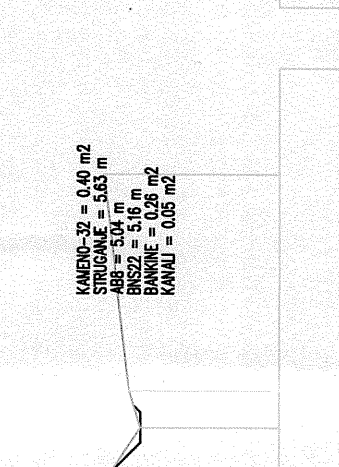

6.059	193.570	4.449	193.430	3.742	194.260	2.614	194.310	2.500	194.580	0.000	194.517	0.000	194.289	2.500	194.260	2.505	194.260	3.292	194.230	4.252	193.710	4.759	193.370	6.049	193.870
-------	---------	-------	---------	-------	---------	-------	---------	-------	---------	-------	---------	-------	---------	-------	---------	-------	---------	-------	---------	-------	---------	-------	---------	-------	---------

188.000
KOLOVOZ
OD.0SE
TEREN
OD.0SE

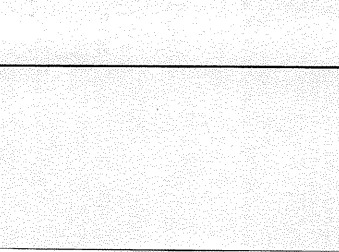

6.059	193.570	4.449	193.430	3.742	194.260	2.614	194.310	2.500	194.580	0.000	194.517	0.000	194.289	2.500	194.260	2.505	194.260	3.292	194.230	4.252	193.710	4.759	193.370	6.049	193.870
-------	---------	-------	---------	-------	---------	-------	---------	-------	---------	-------	---------	-------	---------	-------	---------	-------	---------	-------	---------	-------	---------	-------	---------	-------	---------

CPK - CENTAR ZA PUTEVE DOO
PREDUZEĆE
CPK

INVESTITOR: **OPŠTINA VARVARIN**
OBJEKAT: **Opštinski put Zalogovac - Vratare**
NAZIV PROJEKTA: **GLAVNI PROJEKAT**

ODGOVORNI PROJEKTANT: **Borka Mladenović dipl.ing.grad.**
CRTEŽ: **Poprečni profili od km 0+683.81 do km 0+857.89**
RAZMERA: **R - 1:100**

LIST BR. **5**

08.2012.

8.519	193.460	5.118	193.280	3.396	193.700	2.504	193.810	2.500	194.044	0.000	193.748	0.000	193.981	2.504	193.810	2.504	193.810	3.396	193.700	5.118	193.280	8.519	193.460
-------	---------	-------	---------	-------	---------	-------	---------	-------	---------	-------	---------	-------	---------	-------	---------	-------	---------	-------	---------	-------	---------	-------	---------

5.508	193.020	4.248	193.230	3.535	193.570	2.501	193.520	2.500	193.751	0.000	193.814	0.000	193.814	2.500	193.876	2.698	193.630	3.849	193.410	4.657	193.090	5.416	193.590	9.050	193.590
-------	---------	-------	---------	-------	---------	-------	---------	-------	---------	-------	---------	-------	---------	-------	---------	-------	---------	-------	---------	-------	---------	-------	---------	-------	---------

6.059	193.570	4.449	193.430	3.742	194.260	2.614	194.310	2.500	194.580	0.000	194.517	0.000	194.289	2.500	194.260	2.505	194.260	3.292	194.230	4.252	193.710	4.759	193.370	6.049	193.870
-------	---------	-------	---------	-------	---------	-------	---------	-------	---------	-------	---------	-------	---------	-------	---------	-------	---------	-------	---------	-------	---------	-------	---------	-------	---------

6.059	193.570	4.449	193.430	3.742	194.260	2.614	194.310	2.500	194.580	0.000	194.517	0.000	194.289	2.500	194.260	2.505	194.260	3.292	194.230	4.252	193.710	4.759	193.370	6.049	193.870
-------	---------	-------	---------	-------	---------	-------	---------	-------	---------	-------	---------	-------	---------	-------	---------	-------	---------	-------	---------	-------	---------	-------	---------	-------	---------

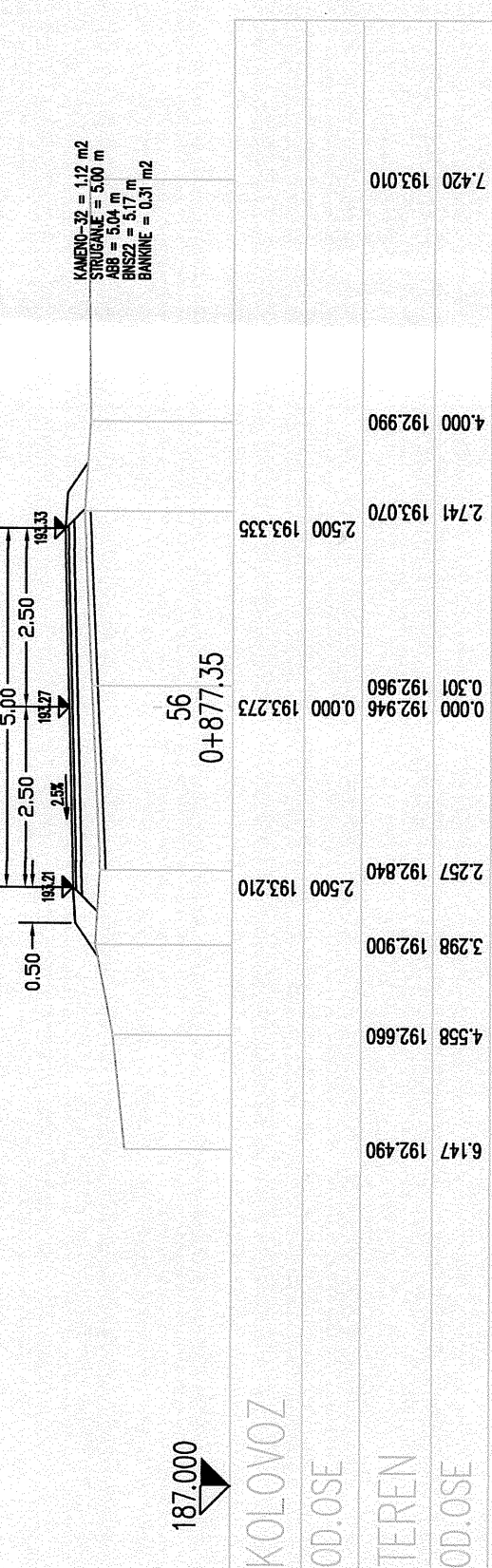

187.000
KOLOVOZ
OD.OSE
TEREN
OD.OSE

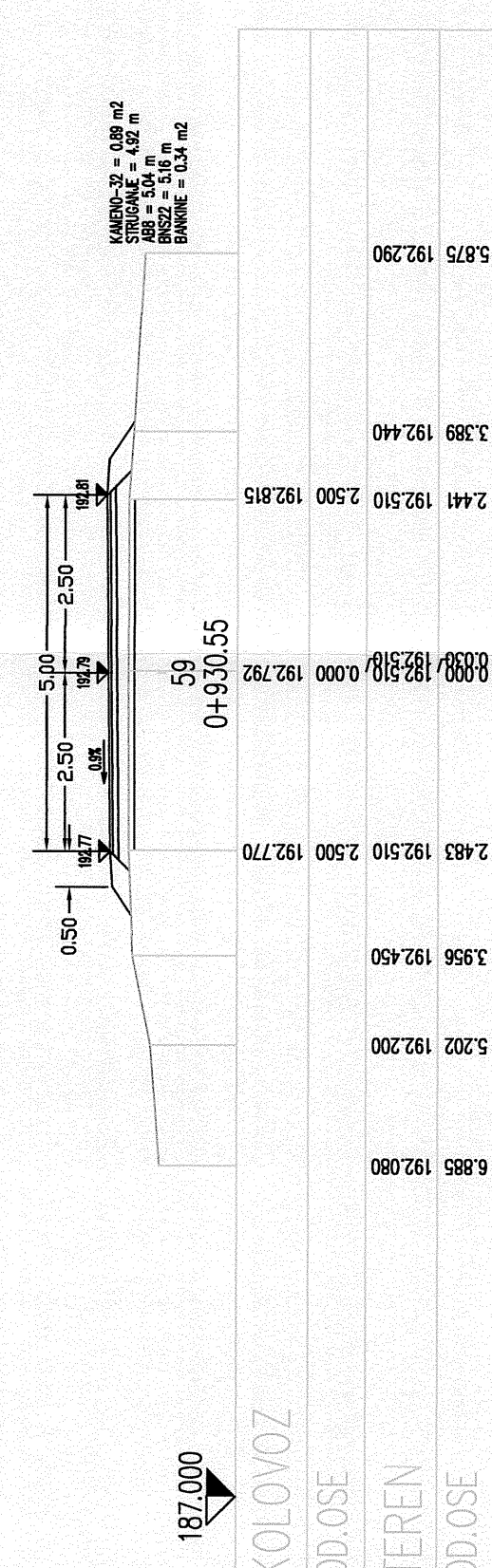

187.000
KOLOVOZ
OD.OSE
TEREN
OD.OSE

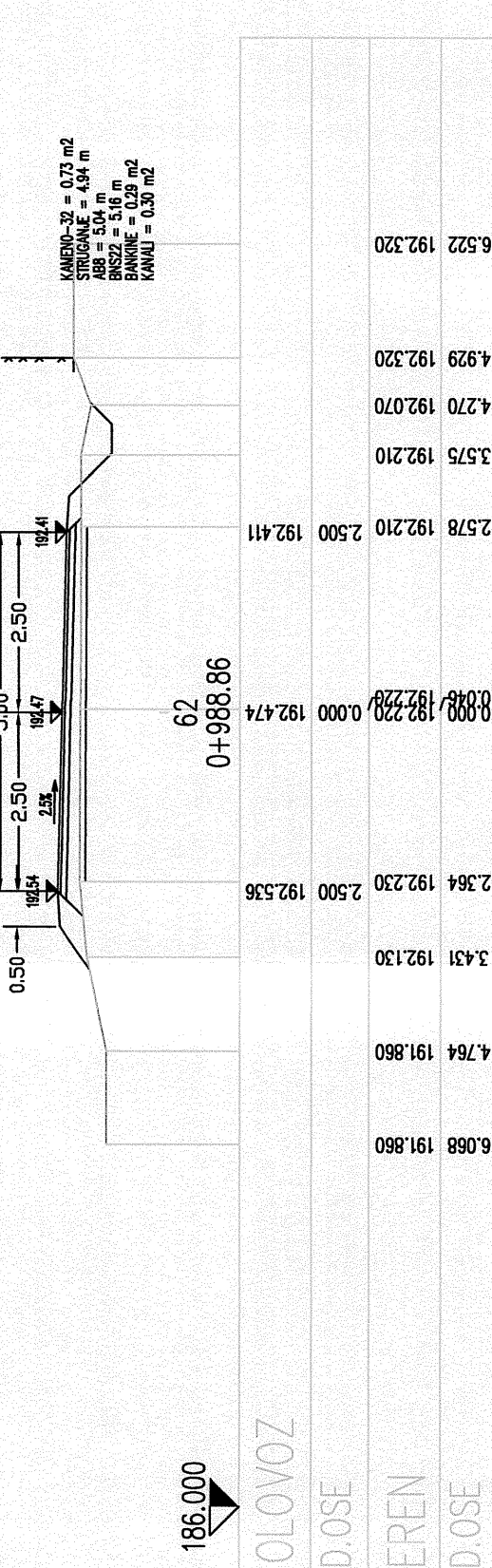

186.000
KOLOVOZ
OD.OSE
TEREN
OD.OSE

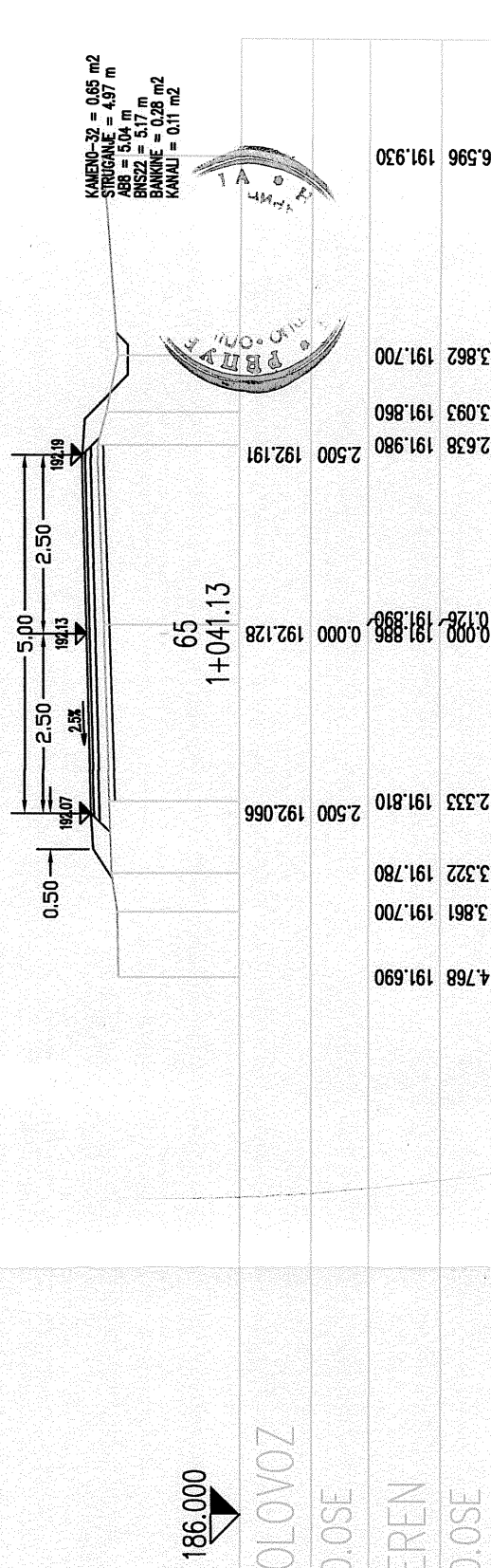

186.000
KOLOVOZ
OD.OSE
TEREN
OD.OSE

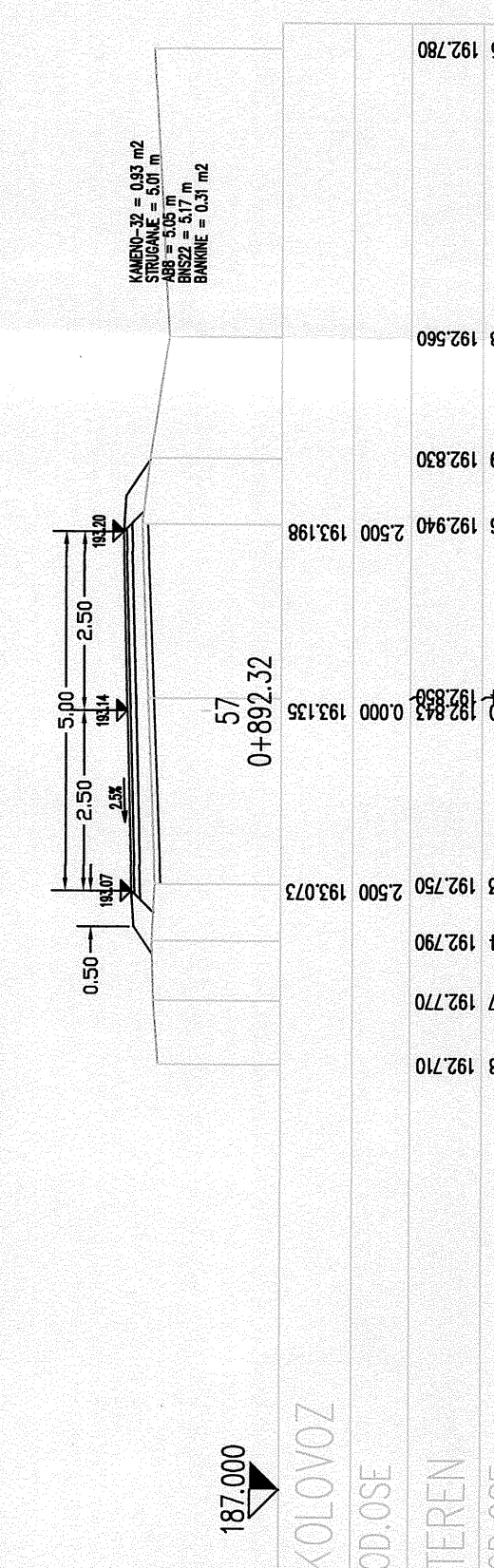

187.000
KOLOVOZ
OD.OSE
TEREN
OD.OSE

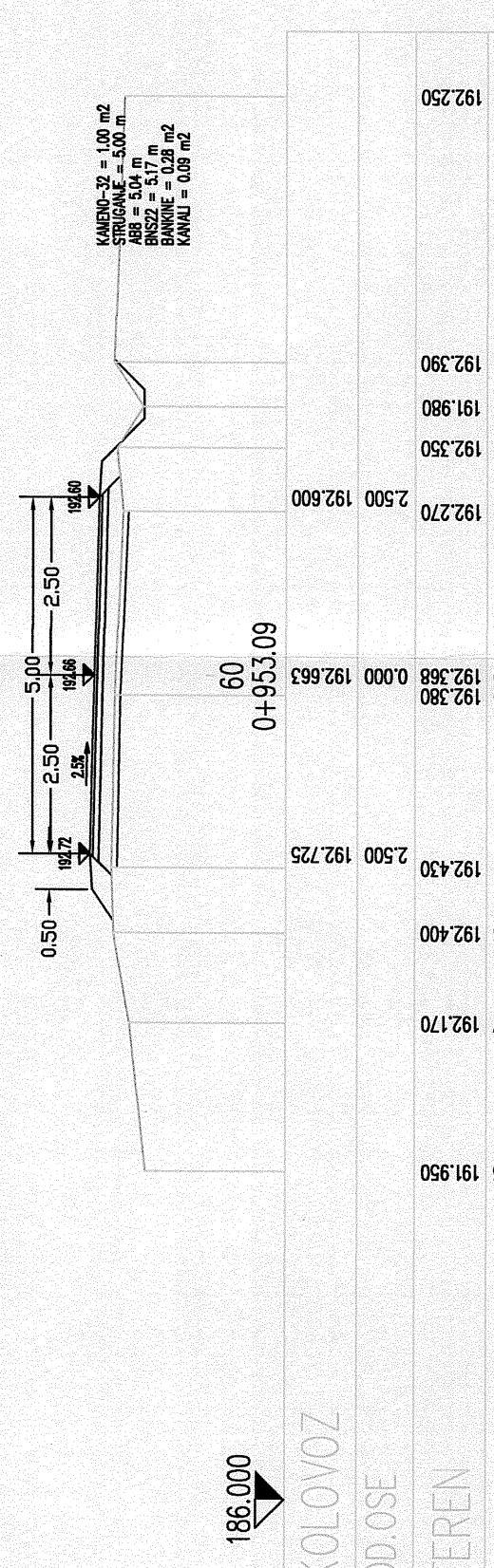

186.000
KOLOVOZ
OD.OSE
TEREN
OD.OSE

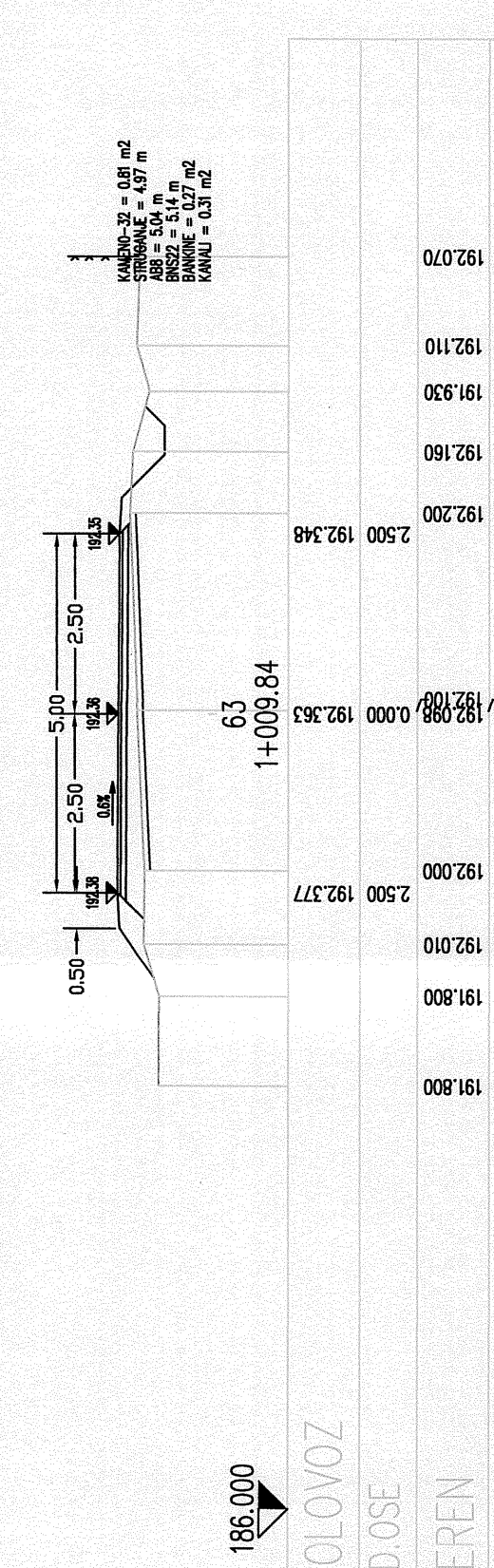

186.000
KOLOVOZ
OD.OSE
TEREN
OD.OSE

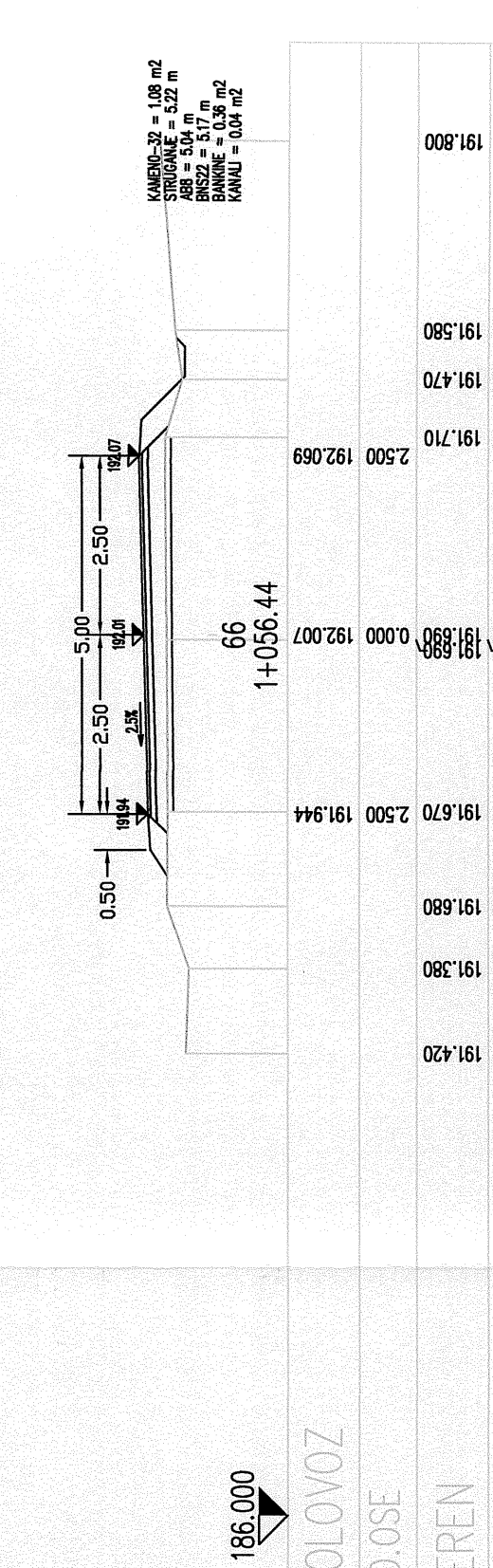

186.000
KOLOVOZ
OD.OSE
TEREN
OD.OSE

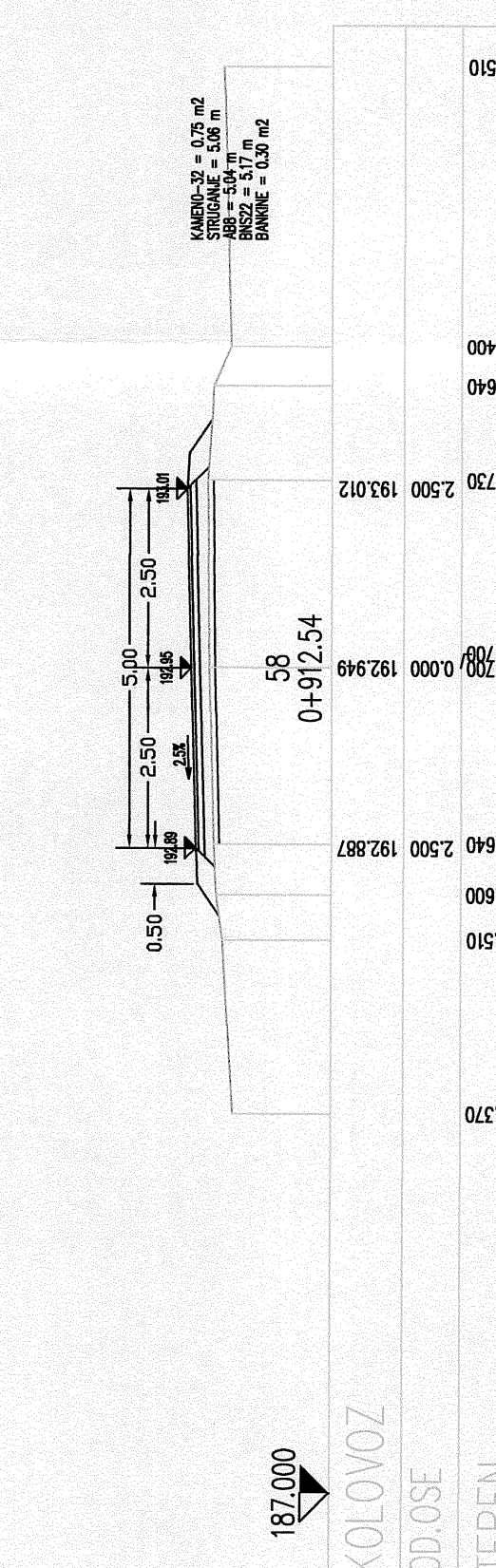

187.000
KOLOVOZ
OD.OSE
TEREN
OD.OSE

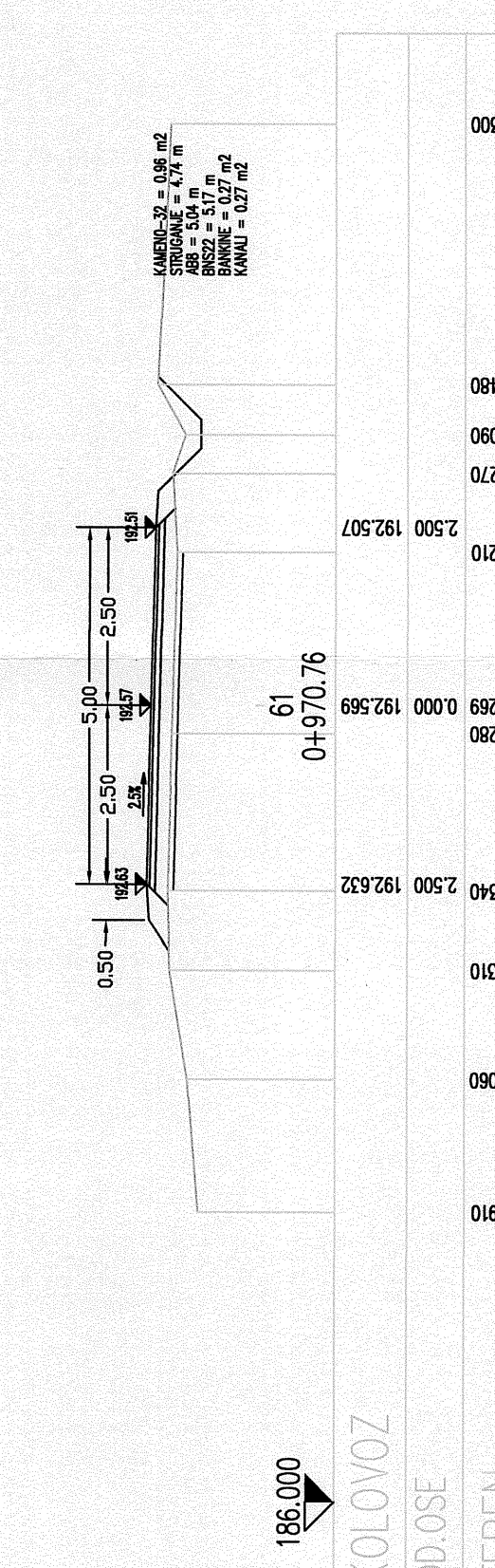

186.000
KOLOVOZ
OD.OSE
TEREN
OD.OSE

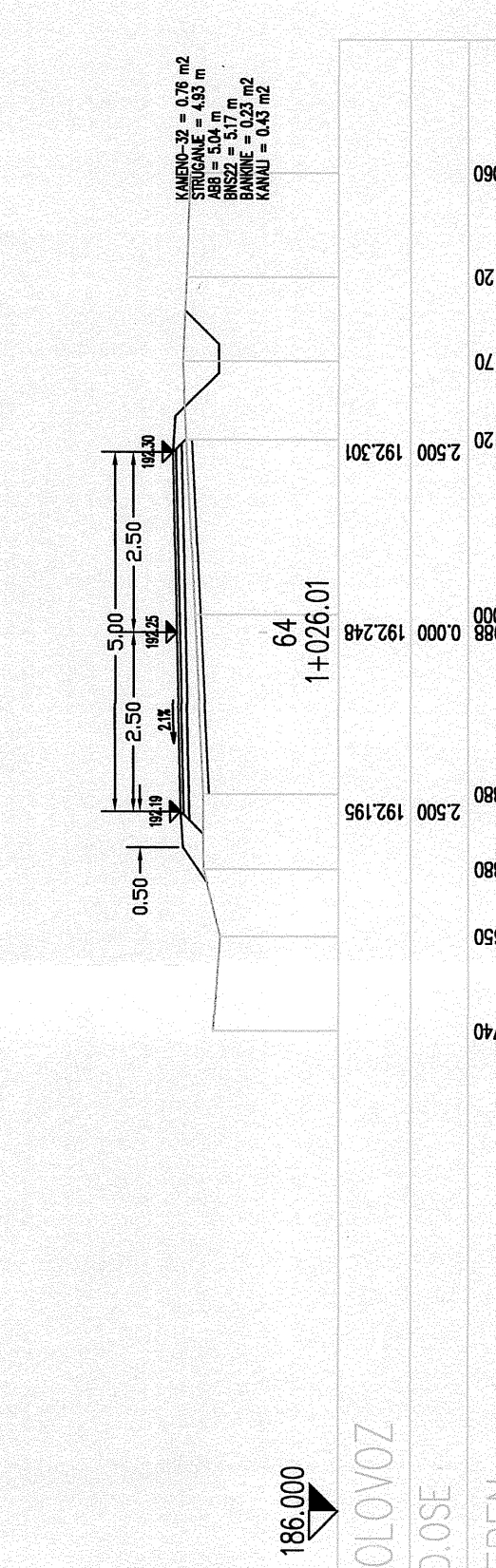

186.000
KOLOVOZ
OD.OSE
TEREN
OD.OSE

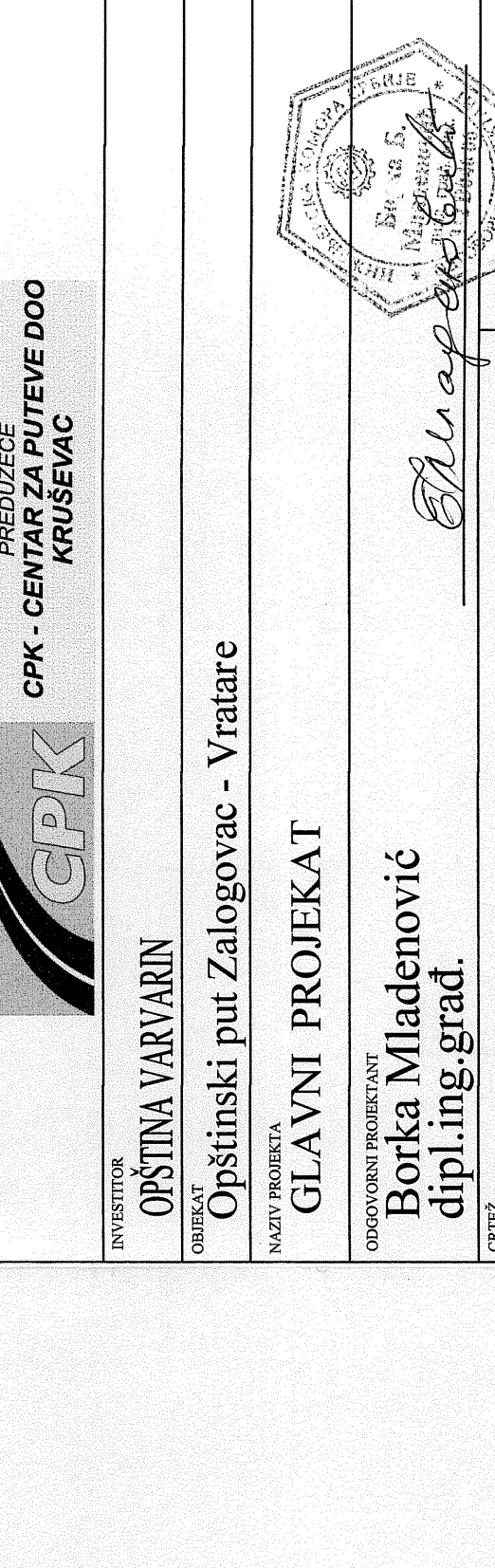

186.000
KOLOVOZ
OD.OSE
TEREN
OD.OSE

CPK - CENTAR ZA PUTEVE DOO
KRUSEVAC

INVESTITOR: **OPŠTINA VARVARIN**
OBJEKT: **Opštinski put Zalogovac - Vratare**
NAZIV PROJEKTA: **GLAVNI PROJEKAT**

ODGOVORNI PROJEKTANT: **Borka Mladenović dipl.ing.grad.**
DATUM: **08.2012.**

LIST BR. **6**